

SAILOR

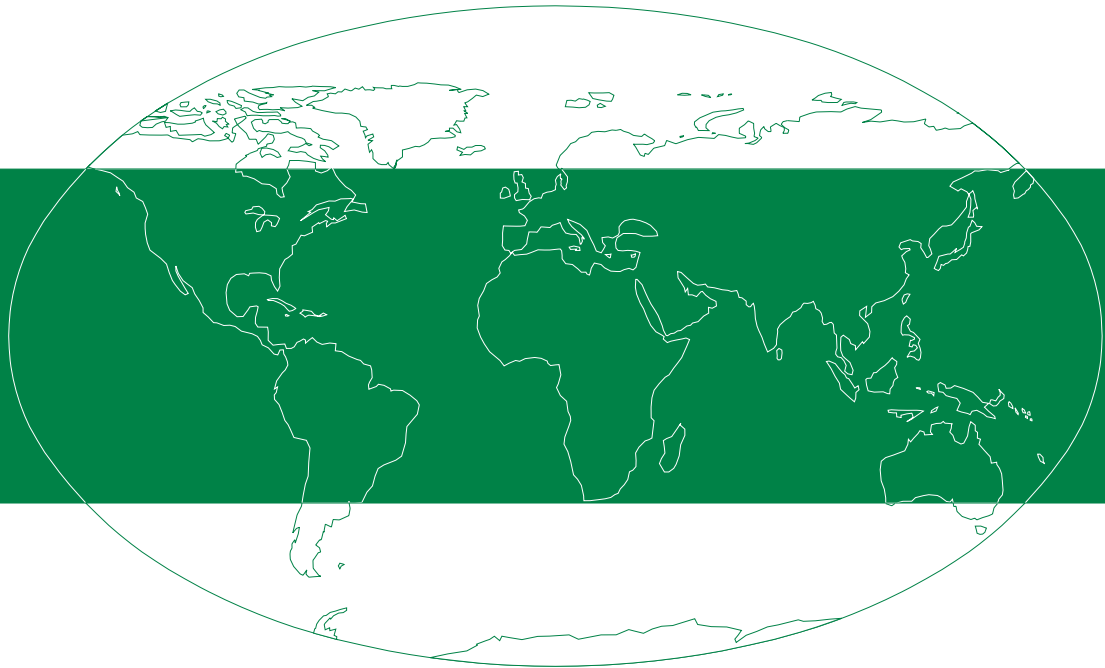

INSTRUCTIONS
FOR
IDENTITY AND SERVICE
PROGRAMMING OF VHF RT2048

Note: This manual is only valid
for microprocessor,
Version **C1106**

ONLY FOR AGENTS AND SERVICE PERSONNEL



S.P. RADIO A/S · AALBORG · DENMARK



SAILOR® · Porsvej 2 · PO Box 7071 · DK-9200 Aalborg SV · Denmark
Phone: +45 9634 6100 · Fax: +45 9634 6101 · Telex: 69789 ECI DK
E-mail: sailor@sailor.dk · Web: www.sailor.dk

CONTENT

		PAGE
1.	HOW TO SELECT SERVICE MODE	1
2.	GENERAL	3
3.	CONVERSION TO HEXADECIMAL NOTATION	4
4.	SERVICE PROGRAMMES AVAILABLE	6
5.	BASIC NECESSARY PROGRAMMING OF RT2048	8
6.	SERVICE PROGRAMME DESCRIPTION	9
7.	MEMORY ALLOCATION TABLE	33
8.	CHANNEL FUNCTION CODE GENERATION	35
9.	CHANNEL FREQUENCY CODE GENERATION	37
10.	COUNTRY VERSION FUNCTION CODE TABLES	44



1. HOW TO SELECT SERVICE MODE

Programming facilities can be selected in one of the following ways:

- 1.a. Remove the cabinet (see mechanical disassembling).
 - b. Place a jumper between pin no. 31 on U03 and ground (on interface unit).
 - c. Switch on the set.
 - d. Perform the service and identity programming in question.
- 2.a. Connect the set to be programmed to another RT2048 (brought into service mode as described under point 1) by means of the programming cable. Both units must be equipped with microcomputers with the SP VHF-bus implemented. This means that the uC must be of revision level C, or later.
 - b. Switch on the set.
 - c. Select service programme F on the unit already in service mode, and press ENTER.
 - d. Perform the service and identity programming in question by using the keyboard on the unit to be programmed.
 - e. Leave service mode, by pressing ENTER on the connected unit and check that your set is operating as wanted.

MECHANICAL DISASSEMBLING RT2048

To disassemble the RT2048 remove the two allen screws with the black covers at the rear of the set and pull the front plate out of the cabinet.

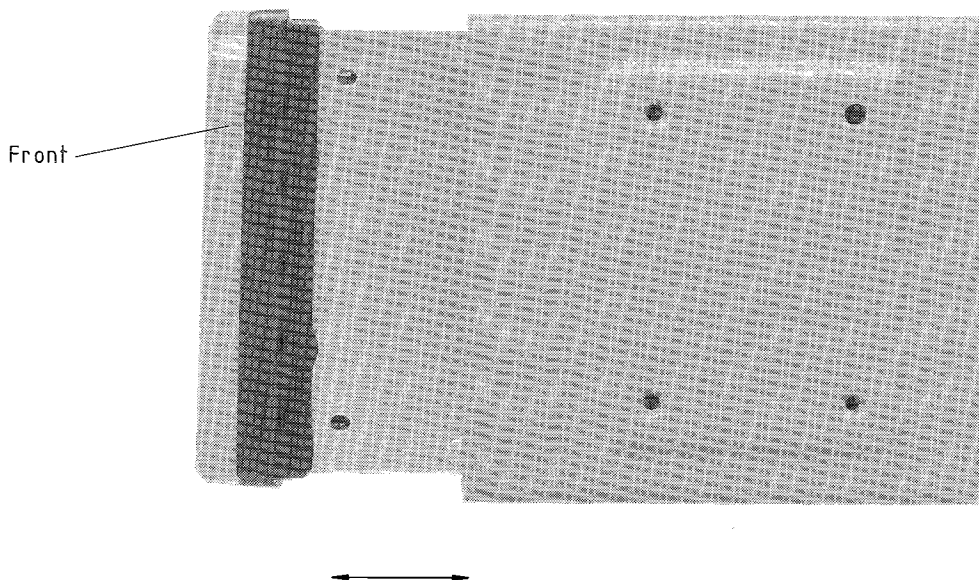

INTERFACE UNIT (MODULE 2)

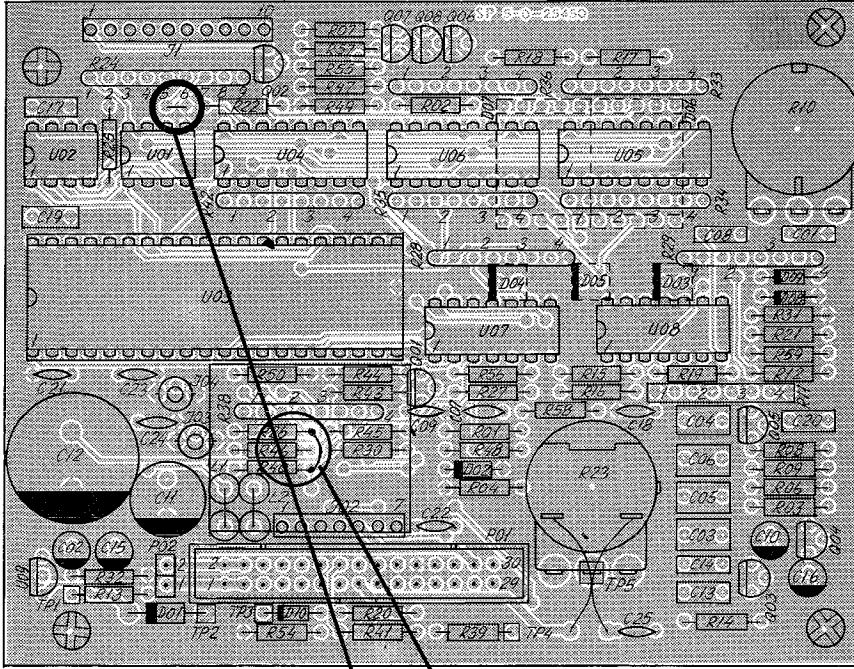

View from component side with upper side tracks.

Ref. Section Sd: Selcall adjustment

Ref. Section 1: How to select service mode

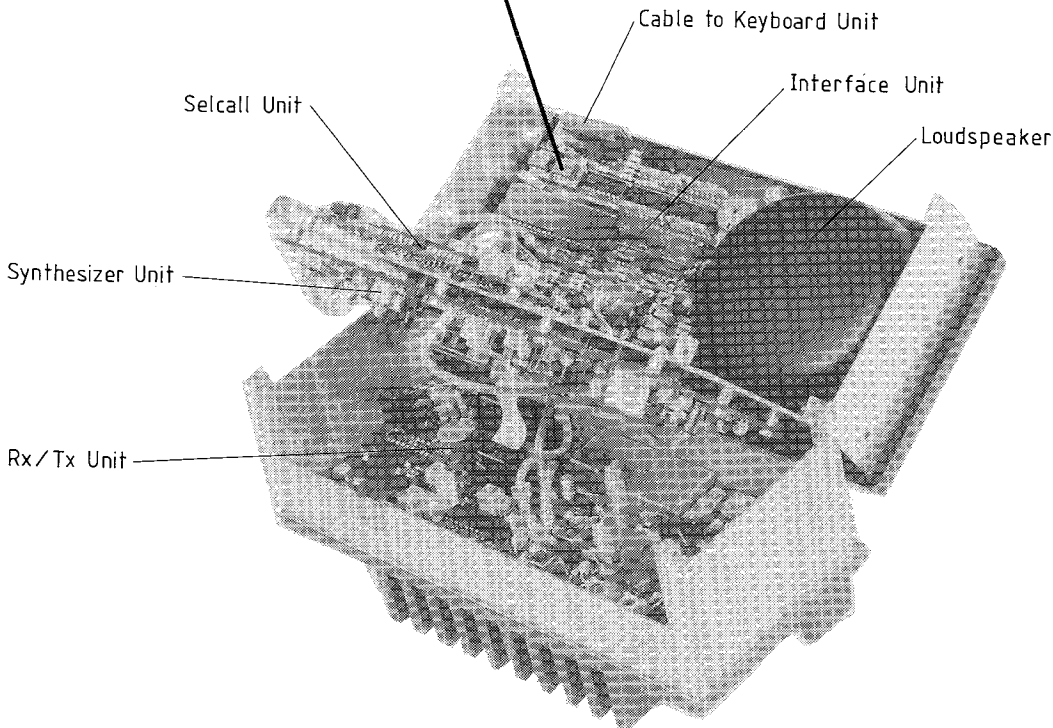

RT2048 Service & Identity
4-6-25450B 4-6-25566

MODULE LOCATION RT2048

2. GENERAL

When the set operating status is changed to service mode, any of the programmable functions or the private channels can be programmed by means of the keyboard.

Besides, a special test mode for adjustment of a selcall filter can be selected.

The internal memory consists of two EEPROM's, each working with 16-bit word length. When the programming is carried out, the microcomputer automatically selects the right PROM for the information being programmed. All information, which can be stored in the memories, are handled as hexadecimal digits. Thus in service mode, the keyboard has the following functions:

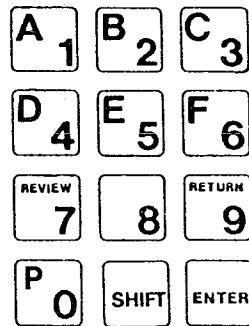

When the set is equipped with a microcomputer of revision level A or later, the revision number can be read in service programme No. H. This programme is selected by keying-in

SHIFT	8
-------	---

 . Now the microcomputer revision level

will be shown in the display when

SHIFT	REVIEW 7
-------	-------------

 is keyed-in.

3. CONVERSION TO HEXADECIMAL NOTATION

A four bit binary number can be converted by means of the table below:

Binary	Hexadecimal	Decimal
0000	0	0
0001	1	1
0010	2	2
0011	3	3
0100	4	4
0101	5	5
0110	6	6
0111	7	7
1000	8	8
1001	9	9
1010	A	10
1011	B	11
1100	C	12
1101	D	13
1110	E	14
1111	F	15

When an 8-bit word has to be converted, just split it up into two 4-bit words consisting of the four most significant bits, respectively the four least significant bits, and convert each of them by means of the above table.

E.g.: bit No.: 7 6 5 4 | 3 2 1 0
 binary code: 1 1 0 0 | 1 0 0 1
 hexadecimal code: C 9

When a decimal number should be converted to hexadecimal code, follow the procedure mentioned below.

Find the nearest lower value in the table below and the corresponding hexadecimal value. Then subtract this decimal value from the actual value and convert the result by means of the table below. Finally add the two hexadecimal figures.

RT2048 Service & Identity

3. CONVERSION TO HEXADECIMAL NOTATION cont.:

Decimal	Hexadecimal	Decimal	Hexadecimal
0	00	0	0
16	10	1	1
32	20	2	2
48	30	3	3
64	40	4	4
80	50	5	5
96	60	6	6
112	70	7	7
128	80	8	8
144	90	9	9
160	A0	10	A
176	B0	11	B
192	C0	12	C
208	D0	13	D
224	E0	14	E
240	F0	15	F

E.g.: Convert 171

The nearest lower value is 160 = A0
 171 less 160 = 11 = B
 Result = AB

Conversion from hexadecimal to decimal.

E.g.: Convert 1A

Find the decimal value corresponding to 10 in the above table.
 Find the decimal value corresponding to A in the above table.
 Finally add the two numbers $10 = 16$
 $A = 10$
 Result $\underline{26}$

4. SERVICE PROGRAMMES AVAILABLE

This part summarizes the service programmes which can be selected by the user.

When service mode is selected the display read-out will be **5.-**. Now any of the service programmes can be selected just by keying in the

programme number followed by an

When the service programme has been selected, an unambiguous identifier is displayed, see the table below.

If you want to return from the selected service programme, just key-in

9, and the display will respond with a read-out of the last selected

service programme number, e.g. **5.7**. Now a new service programme can

be selected as mentioned above.

Service prog. Number	Service programme description	Service prog. Identification
0	This programme is used to programme the DSC/ATIS enable codes, the DSC operating channel and the Transmitter time-out timers. Furthermore, this programme can be used to read and/or change the contents of any of the memory addresses in direct mode, by selecting the addresses one at a time.	00
1	This programme is used to programme the set to the wanted COUNTRY version.	1W C.a.
2	This programme is used to programme the CHANNEL CODE, which describes the status of the channels 15/17, 70 and 75/76.	C.C.
3	This programme is used when the status of the logic output port AUX II should be programmed. This port can be used to indicate that a special channel is selected, e.g. channel 10/13 on river boats or channel 16 distress decoding, when connected to a CRY2001/2.	A.2.
4	This programme is used to define the ENABLE CODE for the set. This code describes the working facilities concerning scanning, US/K mode, additional private channels, special function code for international channels, selcall, and D.W. enable etc.	E.C.
5	This programme is used to programme the QUICK CHANNEL number, normally channel 16.	Q.C.
6	This programme is used to programme the DUAL WATCH preference CHANNEL, which will normally be channel 16.	d.C.

4. SERVICE PROGRAMMES AVAILABLE cont.:

Service prog. Number	Service programme description	Service prog. Identification
7	<p>This programme is used to programme the function/frequency codes for PRIVATE CHANNELS P0-P9.</p>	<p>Ch. 1W</p>
8	<p>This programme is used to programme the function/frequency codes for PRIVATE CHANNELS A0-A9, E0-E9, and F0-F9 if they are selected by means of the enable code. NOTE! If the enable code does not open for additional 30 private channels, this programme cannot be entered.</p>	<p>Ch. 1W</p>
9	<p>This programme is used when the set should be used in special frequency bands. In this case a BAND-shift CODE and a synthesizer offset constant should be programmed.</p>	<p>bc. 1W</p>
A	<p>This programme is used to specify the maximum NUMBER of CHANNELS which can be stored in a scanning sequence. NOTE! If the enable code does not open up the scanning facilities, this programme cannot be entered.</p>	<p>n.c.</p>
b	<p>This programme can COPY any of the function code tables for the international channels into the EEPROM. The function code tables can be any of the country versions available. NOTE! If the enable code does not specify the function code for the international channels to be in the EEPROM, this programme cannot be entered.</p>	<p>C.P.</p>
c	<p>This programme is used when you want to programme or EDIT CODES in the function code table for the international channels placed in the EEPROM. NOTE! If the enable code does not specify the function code for the international channels to be in the EEPROM, this programme cannot be entered.</p>	<p>E.C. 1W</p>
d	<p>This programme has to be used when a SELCALL ADJUSTMENT procedure has to be carried out. When selected, the microcomputer will generate an appropriate adjustment tone for the selcall filter. NOTE! This programme MUST NOT be selected if the enable code does not enable the selcall option. If this happens the set has to be switched off and on before further programming can proceed.</p>	<p>S.A.</p>

RT2048 Service & Identity B

4. SERVICE PROGRAMMES AVAILABLE cont.:

Service prog. Number	Service programme description	Service prog. Identification
E	When a selcall module or an ATIS module are installed, the appropriate user number can be entered by means of this programme digit by digit. NOTE! The appropriate options must be enabled, before the number programming can be carried out (only one option must be enabled at a time during programming).	d.1
F	This IDENTITY programme can be used to select service mode or another RT2048, connected to this unit by means of a programming cable.	E.5.

5. BASIC NECESSARY PROGRAMMING OF RT2048

The basic programming sequence for a new RT2048 will include the following steps.

- a. Select and programme the COUNTRY version, service programme No. 1.
- b. Determine and programme the CHANNEL CODE for the channels 15/17, 70 and 75/76 by means of service programme No. 2.
- c. Determine and programme the ENABLE CODE for the wanted version by means of service programme No. 4.
- d. Programme the QUICK CHANNEL number by means of service programme No. 5.
- e. Programme the DW preference CHANNEL by means of service programme No. 6.
- f. Programme the DSC/ATIS enable codes by means of service programme number 0.
- g. Programme or inhibit the Transmitter time-out timers by means of service programme number 0.

If the ENABLE CODE opens for the scanning facilities:

- h. Programme the maximum number of channels in a scanning sequence by means of service programme No. A.

When a selcall unit should be installed, the programming should include the following step:

- i. Programme the user selcall number by means of service programme No. E.

The remaining service programmes should only be used in installations where special programming and/or option interfaces should be used.

6. SERVICE PROGRAMME DESCRIPTION

5.0 DIRECT ADDRESS PROGRAMMING

GENERAL USE OF THIS SERVICE PROGRAMME

This programme permits you to programme each of the memory addresses directly. As mentioned in the general part, the memory is working with 16-bit words in all available addresses.

Because of the limits of visual indication, these words are split up into two 8-bit words called High Byte, respectively Low Byte. With High Byte representing the 8 most significant bits in the 16-bit word.

The read-out of both address and content will always be by use of hexadecimal digits.

The meaning of the two digit read-out is distinguished by means of the LED-indicators 1W, TX, US.

E.g.

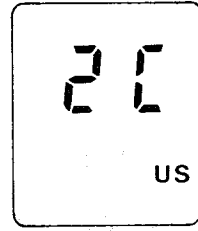
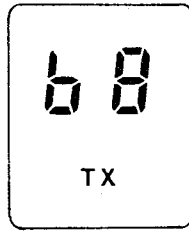
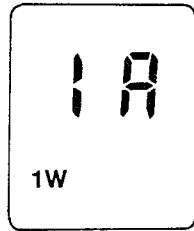



Address number 1A



High Byte value B8

Low Byte value 2C

Thus successive activation of the  key will result in a read-out

sequence as follows: Address number, High Byte value, Low Byte value, next Address number etc.

When pressing  , the last address number which has been selected by use of the keyboard  button will be read-out in the display.

The service programme will be left by entering the sequence   and the number of the last selected service programme will be displayed

5.0

PROGRAMMING OF DSC/ATIS ENABLE CODES

If the transceiver is going to operate with an RM2042 or with an optional ATIS module, the appropriate enable code must be programmed as the most significant digit in address BHIGH. The least significant digit in address BHIGH contains the programming of AUXII and must be left unaltered. The value of the digit in question must be determined by means of the following truth table:

6. SERVICE PROGRAMME DESCRIPTION cont.:

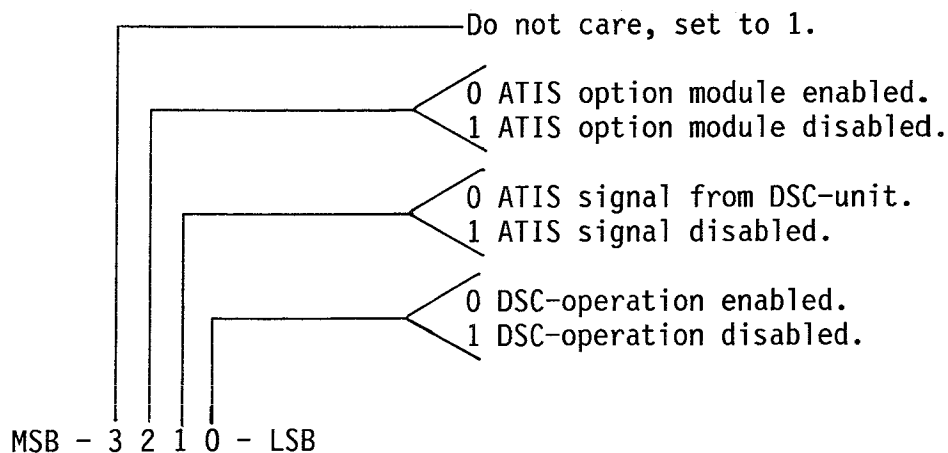

Remember that you have to convert the binary code to hexadecimal notation before programming.

PROGRAMMING OF TRANSMITTER TIME-OUT TIMERS

In some countries the authorities do not permit an unlimited, continuous transmission from the transceiver. Therefore, it is possible to programme the maximum length of an uninterrupted transmission and the minimum time, which has to elapse before the transmitter can be re-keyed.

The values of the transmitter time-out timers, must be stored in address 2ELOW. The most significant digit on this address determines the maximum time of continuous transmission. The value can be programmed in steps of 1 minute, so with this 4 bit value, the time will be between 1 and 15 minutes.

The least significant digit on this address determines the minimum time where transmission is inhibited. The value can be programmed in steps of 1 second, so with this 4 bit value, the time will be between 1 second and 15 seconds.

Example. If the hexadecimal code A5 is programmed, the maximum continuous transmission will be limited to 10 minutes, and transmission will be inhibited for 5 seconds if a time-out has occurred.

If you want to disable these timers a 00 should be programmed.

PROGRAMMING OF DSC-OPERATING CHANNEL AND IDENTITY CODE

In normal use, the DSC-channel will always be channel 70, but for test purposes, it can be very convenient to transmit DSC-messages on other channels than channel 70. Therefore, the DSC-operating channel has been made programmable, and the channel must be stored in address 2FHIGH.

A programming example is shown below where channel 70 as a standard is programmed.

The identity code must be 01 and should be programmed in address 2F_{LOW}.

6. SERVICE PROGRAMME DESCRIPTION cont.:

1. Select service mode

2. Select service programme 0

3. Select the appropriate address number (see chapter 7) here address No. 2F.

4. Select the appropriate byte, here High Byte (actual content channel 16).

5. Key-in the wanted channel number.

6. Store the new DSC channel No. (now the Low Byte will be read-out).

7. Key-in the identity code = 01.

8. Store the identity code 01. (now the address will be read-out).

9. Leave the service programme.

Keyboard input	Read-out
	5.-
P 0	5.0
ENTER	00 1W
B 2	2
SHIFT F 6	2F 1W
ENTER	16 TX
REVIEW 7 P 0	70 TX
ENTER	FF US
A 1	01 US
ENTER	30 TX
SHIFT RETURN 9	5.0



5.1 COUNTRY VERSION PROGRAMMING

This programme is used for easy programming of the wanted country version. It is possible to choose between 15 different country versions without making any special function code programming of the international channels. The available versions are listed in the table below and the function code tables belonging to them can be found in chapter 10. When the service programme has been selected, the actual version can be displayed just by pressing



Country vers. No.	Note No.	Version	Private channels				
			P0	P1	P2	P3	P4
0	-	Standard Int.	-	-	-	-	-
1	-	Stand. w.pleas. boat ch's DK	-	-	-	1L	2L
2	-	Stand. w.pleas. boat ch's N	-	L1	L2	L3	-
3	-	Standard w.fishing boat ch's	-	F1	F2	F3	-
4	-	Standard w.weather channels	-	WX1	WX2	WX3	WX4
5	-	Standard w.22A	22A	-	-	-	-
6	-	Stand. w.22A + weather ch's	22A	WX1	WX2	WX3	WX4
7	-	Standard w.channel 37	-	37	-	-	-
8	-	Standard Int.	-	-	-	-	-
9	-	All ch's 00->99 as simplex	-	-	-	-	-
A	-	Belgium, inland	-	-	-	-	-
B	-	France, inland	-	-	-	-	-
C	-	Germany, inland	-	-	-	-	-
D	1	Netherlands, inland	-	-	-	-	-
E	-	Standard Int.	-	-	-	-	-
F	2	US-mode w. 1W on ch. 13/67	-	WX1	WX2	WX3	WX4









Note 1. When the set is equipped with a microcomputer of revision level A or later, this country version includes ch. 30 as a 1W duplex channel.

Note 2. When this country version has been selected, the set will operate in US-mode automatically. If this country version has been selected and the ENABLE CODE specifies US-mode enabled, the set can be changed between US-mode and INT-mode with 1W and "long-push" function on ch.13/67 in both operating modes. However, if the ENABLE CODE specifies K-mode enabled, the set will only have 1W and "long push" function on ch. 13/67, when operating in US-mode.

PS! If a country version including private channels has been selected, these will have priority compared to private channels with the same number in the EEPROM's which will be ignored.

E.g. Programme the set to run as a standard with weather channels and verify that your programming has been carried out correctly.

6. SERVICE PROGRAMME DESCRIPTION cont.:

	Keyboard input	Read-out
1. Select service programme 1		5.1
		Co.
2. Key-in the appropriate country version No. 4. (according to table above)		4
3. Store the country version No.		5.1
4. Select service programme No. 1 again to verify programming.		Co.
5. Look-up the actual version No.	 	4
6. Leave the service programme.	 	5.1

Now another service programme can be selected just by keying in the number followed by an enter.

6. SERVICE PROGRAMME DESCRIPTION cont.:

5.2 CHANNEL CODE PROGRAMMING

Due to the different requirements from the PTT's concerning the mode of operation on the channels 15/17, 70 and 75/76, a special programming is necessary.

The correct channel code can be made by means of the table below. This binary code should be converted to hexadecimal before programming e.g. by means of chapter 3.

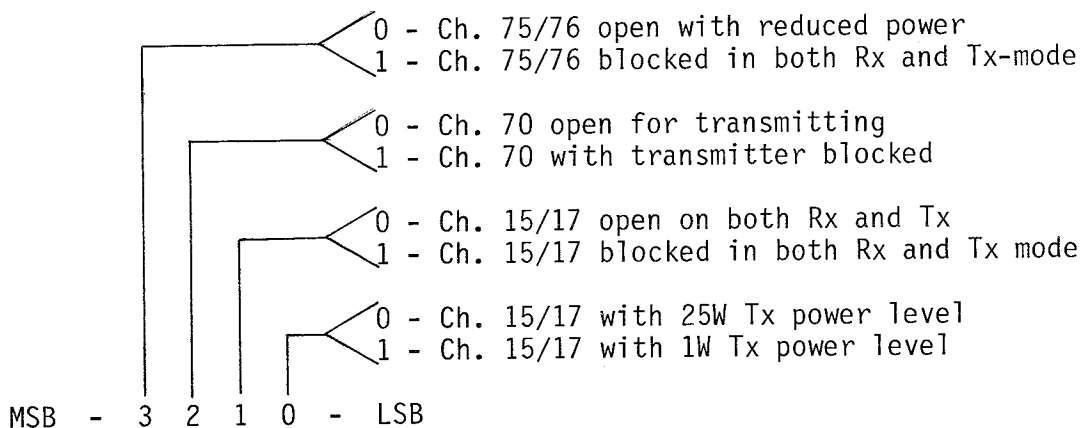

E.g. Determine and programme the channel code for a set which should be blocked on ch. 75/76 with transmitter blocked on ch. 70 and running with full power on ch. 15/17.

By use of the above table; the following binary channel code is found 1 1 0 0, which converted to hexadecimal notation means a C.

1. Select service programme No. 2.

2. Note the actual channel code (e.g. d)

3. Key-in the wanted value, C.

4. Store the new channel code. (the last selected service programme will be displayed.)

Keyboard input	Read-out
B 2	5.2
ENTER	C.C.
SHIFT REVIEW 7	d
SHIFT C 3	C
ENTER	5.2

Now another service programme can be selected just by keying-in the number followed by an enter.

PS! It should be noticed that the operation on the channels covered by the channel code, is completely determined by the channel code independent of the selected country version.

NOTE! If the ENABLE CODE specifies the function code for all 'ch's to be in the EEPROM, this CHANNEL CODE programming is ignored.

6. SERVICE PROGRAMME DESCRIPTION cont.:

5.3 AUX II PORT PROGRAMMING

This programme is used to determine the operation of the logic output port, named AUX II. This port can be used to indicate when some special channels have been selected, when the set is operating.

This port can be used in conjunction with an option board, e.g. for muting of external equipment or for distress decoding when used in conjunction with an encryption unit.

The binary code for the operation of AUX II can be determined by means of the table below. This code has to be converted to hexadecimal before programming.

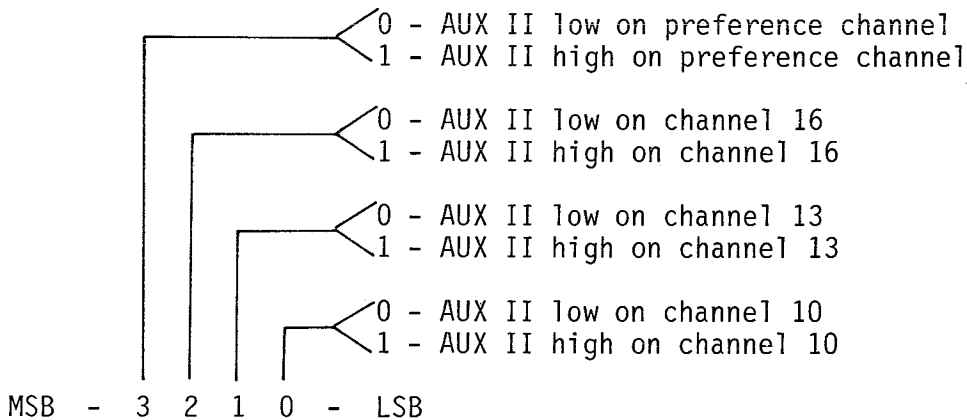

E.g. Determine the code and programme the AUX II port to be high on ch. 10 and 13.

By use of the table above, the binary code can be determined to be 0 0 1 1, which means 3 in hex-code.

1. Select service programme No. 3

2. Key-in the wanted value, 3.

3. Store the AUX II code.

Keyboard input	Read-out
	5.3
	A.2.
	3
	5.3

If you want to check the programmed value, just enter the service programme again and press , and the content will be read-out. Now leave the

service programme with non-affected memory content by pressing

6. SERVICE PROGRAMME DESCRIPTION cont.:

5.4 ENABLE CODE PROGRAMMING

By means of this code the wanted programmable features are defined. This means enabling of US-mode, scanning facilities etc.

The enable code consists of a two digit hexadecimal code, which can be determined by means of the tables below.

The most significant digit is determined by the following:

0 0 X X	US/K-mode disabled
0 1 X X	US-mode enabled
1 0 X X	K-mode enabled, see Note 1.
1 1 X X	US/K-mode disabled
X X 0 0	Scanning and additional private ch.'s disabled
X X 0 1	30 additional private channels enabled
X X 1 0	Scanning enabled with scan times from 1-99 secs
X X 1 1	Scanning enabled with scan times from 1-10 secs

MSB - 3 2 1 0 - LSB

and the least significant digit by this table:

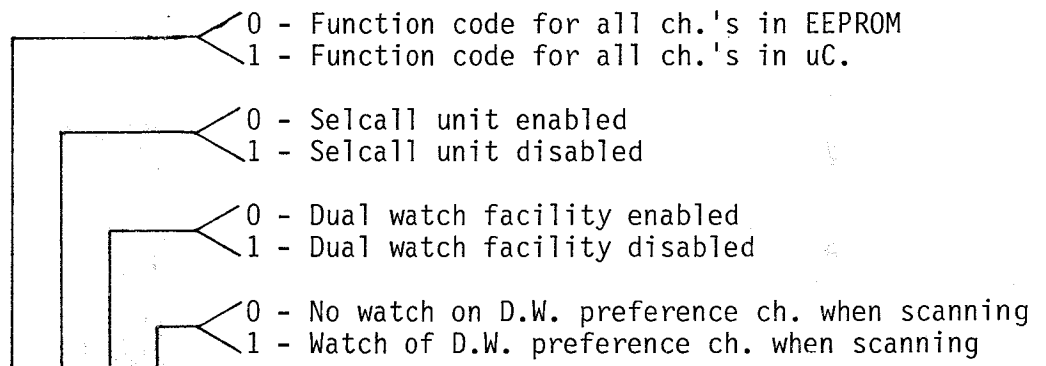

MSB - 3 2 1 0 - LSB

Note 1. When K-mode is enabled, the "US" push button will change the operating country version from the one selected in service programme No. 1 and a standard Int. version and vice versa.

E.g. Programme the set to run with scanning facilities and US-mode enabled. Standard function code for international channels; without selcall unit, with D.W.-facility enabled and watch of ch. 16 when scanning.

From the upper table the binary code for the most significant digit is determined to be 0 1 1 0, which converted to hex-code means a 6.

From the lower table the binary code for the least significant digit is determined to be 1 1 0 1, converted to a D in hex-code.







So the ENABLE CODE should be programmed to be 6D in the following way:



6. SERVICE PROGRAMME DESCRIPTION cont.:

1. Select service programme No. 4

2. Key-in the value of the hex-code.

3. Store the new Enable Code.

Keyboard input	Read-out
	5.4
	E.C.
	6
 	6d
	5.4

The new Enable Code can be checked by entering the service programme again and use the   function. If a wrong digit is keyed-in in an input sequence, just repeat with the wanted input sequence, the memory content will not be affected before an  is executed.

6. SERVICE PROGRAMME DESCRIPTION cont.:

5.5 QUICK CHANNEL NUMBER

This programme is used to programme the channel number connected to the "quick channel" - push button, which normally will be channel 16. The quick channel number can be any of the valid channels in the set, this means a channel with a function code differing from FF. The actual quick channel number can be read by entering the service

programme and use the **SHIFT** **REVIEW 7** function.

The quick channel number is programmed just by keying-in the wanted channel number, e.g. as follows for channel 69:

	Keyboard input	Read-out
1. Select service programme No. 5	E 5	5.5
	ENTER	0.0.
2. Key-in the wanted channel number.	F 6	6
	RETURN 9	69
3. Store the quick channel No.	ENTER	5.5

Now the set is ready for selection of a new service programme - if wanted.





6. SERVICE PROGRAMME DESCRIPTION cont.:

5.6 DUAL WATCH PREFERENCE CHANNEL

This programme is used for easy programming of the D.W.-preference channel, which will normally be ch. 16.

The D.W.-preference channel can be any of the valid channels in the set, this means a channel with a function code differing from FF.

The programming of the D.W.-preference channel is made directly as shown below, where ch. 10 should be the preference channel.

	Keyboard input	Read-out
1. Select service programme No. 6		5.6
		d.f.
2. Key-in the wanted channel number.		1
		10
3. Store the new D.W.-preference ch.		5.6

If for example a non-valid channel is programmed as the D.W.-preference channel, e.g. a private channel which has not been programmed, the set will not start dual watching when keyed-in, in spite of the dual watch facility being enabled by use of service programme No. 4.

6. SERVICE PROGRAMME DESCRIPTION cont.:

5.7 PRIVATE CHANNELS P0 -> P9

This programme is used to programme the information needed for a normal private channel in the basic frequency band.

A private channel is specified by means of the channel number and the two hexadecimal numbers describing the connected function code and frequency code.

When the wanted operation mode and frequency is determined, the appropriate hex-codes can be determined by means of the tables in chapter 8 and 9.

The meaning of the two digit read-out is distinguished by means of the three LED-indicators 1W, TX, US.

E.g.

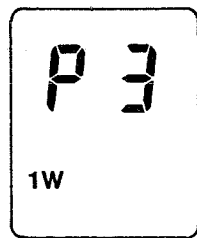

Channel number
P3

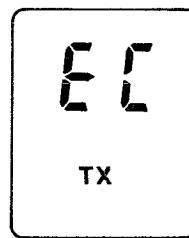

Function code
EC

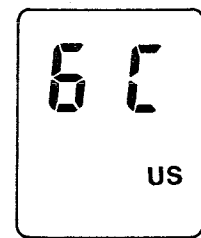

Frequency code
6C

Successive activation of the **ENTER** key will result in a sequence where the programme asks for the channel number **Ch.**, the function code **Fu.** and the frequency code **Fr.**. In each step the actual value can be displayed just by pressing **SHIFT** **REVIEW 7**. The programme can be left at any time by pressing **SHIFT** **RETURN 9**, without changing the memory content.

If a wrong key has been activated in a data input sequence, just restart the input sequence and the digits will roll lefthand out of the display. Only the displayed code will be stored when the enter key is activated.

E.g. Programme a private channel in P0 with the function code EC and the frequency code 6C.

1. Select service programme No. 7.

2. Key-in the channel No. to be programmed.

Keyboard input	Read-out
REVIEW 7	5.7
ENTER	Ch. 1W
SHIFT P0	P 1W
P0	P0 12 1W

6. SERVICE PROGRAMME DESCRIPTION cont.:

3. Store the channel No. to be programmed.

4. Key-in the function code, here EC in hexadecimal notation.

5. Store the function code.

6. Key-in the frequency code, in this case 6C.

7. Store the frequency code.

Keyboard input	Read-out
ENTER	F u. TX
SHIFT E 5	E TX
SHIFT C 3	E.C. TX
ENTER	F r. US
F 6	6 US
SHIFT C 3	6C US
ENTER	Ch. 1W

Now another channel can be programmed in the same way, or the service programme can be left by pressing **SHIFT** **RETURN 9**

It must be noticed that all non-valid private channels must be programmed with an FF in the function code register.

PS! If a country version with pre-programmed private channels are selected, the set will neglect possible user programmed channels with the same channel number.

6. SERVICE PROGRAMME DESCRIPTION cont.:

5.8 PRIVATE CHANNELS A0-A9, E0-E9, F0-F9.

When additional 30 private channels are selected by means of the ENABLE CODE, this programme can be used to programme the information needed for a normal private channel in the basic frequency band. The mode of operation of this programme is exactly the same as programme No. 7 used for programming of private channels P0-P9. E.g. Programme a private channel in F4 with the function code EE and the frequency code 58.

RT2048 Service & Identity

	Keyboard input	Read-out
1. Select service programme No. 8.	<input type="button" value="8"/>	5.8
	<input type="button" value="ENTER"/>	[h. 1W
2. Key-in the channel No. to be programmed.	<input type="button" value="SHIFT"/> <input type="button" value="F6"/>	F 1W
	<input type="button" value="D4"/>	F4 1W
3. Store the channel No. to be programmed.	<input type="button" value="ENTER"/>	F u. TX
4. Key-in the function code, in this case EE.	<input type="button" value="SHIFT"/> <input type="button" value="E5"/>	E TX
	<input type="button" value="SHIFT"/> <input type="button" value="E5"/>	EE TX
5. Store the function code.	<input type="button" value="ENTER"/>	F r. US
6. Key-in the appropriate frequency code, here 58.	<input type="button" value="E5"/>	5 US
	<input type="button" value="8"/>	58 US
7. Store the frequency code	<input type="button" value="ENTER"/>	[h. 1W

6. SERVICE PROGRAMME DESCRIPTION cont.:

The programming just carried out can now be checked using the function and the



push button.

It must be noticed that all non-valid private channels must be programmed with an FF in the function code register.

5.9 BAND-SHIFT CODE PROGRAMMING

This programme should be used when special frequency coding is specified in a channel function code.

Therefore, when operating above or below the basic frequency band, when moving the "fixed frequency" channels 00 -> 99, or a special "duplex distance" is wanted, this programme is used to programme the band-shift code, the base constant for the "fixed frequency" channels, and the receiver frequency offset constant.

When the transmit and receive frequencies are given, the appropriate band-shift code, transmitter base constant, and receiver offset constant can be determined by means of the formulas given in chapter 9.

The band-shift values are decimal numbers between -2 and +2. The appropriate binary coding of these codes can be determined by means of the following table:

0 0 X X	Band-shift inhibited
0 1 X X	Sign of band-shift constant is plus
1 0 X X	Sign of band-shift constant is minus
1 1 X X	Band-shift inhibited
X X 0 0	Numerical value of band-shift constant = 0
X X 0 1	Numerical value of band-shift constant = 1
X X 1 0	Numerical value of band-shift constant = 2
X X 1 1	Numerical value of band-shift constant = 0

MSB - 3 2 1 0 - LSB

When the binary codes are determined they must be converted to hexadecimal digits before programming.

The two digit hex codes has the most significant digit representing the bandshift number for the transmitter (B_{TX}) and the least significant digit representing the band-shift number for the receiver (B_{RX}).

The transmitter base constant is a decimal number between 0 and 254, which just has to be converted to a two digit hexadecimal number before programming, e.g. by means of the tables in chapter 3.

The receiver offset constant is also a decimal number between 0 and 254, which have to be converted to a two digit hexadecimal number before programming, e.g. by means of the tables in chapter 3.

E.g. Find and programme the band-shift code, the transmitter base constant and the receiver offset constant, when the decimal numbers are determined to be $B_{TX} = +1$, $B_{RX} = -1$ and $bP = 0$ and $nP = 40$.











By means of the table above, the binary code for $B_{TX} = +1$ will be 0 1 0 1, which equals 5 in hex-code. For $B_{RX} = -1$ the binary code will be 1 0 0 1, which means 9 in hex-code.

So the band-shift code (bc.) should be 59.

The transmitter base constant equals 0.

The receiver offset constant equals 28 when converted to hex-code.

6. SERVICE PROGRAMME DESCRIPTION cont.:

	Keyboard input	Read-out
1. Select service programme No. 9.		5.9
		b.c. 1W
2. Key-in the band-shift code.		05 1W
		5.9 1W
3. Store the band-shift code.		bP. TX
4. Key-in the transmitter base constant, in this case 0.		00 TX
5. Store the transmitter base constant.		nP. US
6. Key-in the receiver offset constant in this case 28.		02 US
		28 US
7. Store the receiver offset constant.		5.9

It should be noticed that the band-shift coding will only be used on channels where the function code specifies "special frequency coding".

6. SERVICE PROGRAMME DESCRIPTION cont.:

5.A

MAXIMUM NUMBER OF CHANNELS IN SCANNER

When the equipment ENABLE CODE permits the set to scan, this programme is used to specify the maximum number of channels which can be stored in the scanning sequence.

The number must be stored as a hexadecimal number.

E.g. Specify the maximum number of channels to be 10.
Converted to hex-code this means an A.

	Keyboard input	Read-out
1. Select service programme No. A	<div style="display: flex; justify-content: space-around; align-items: center;"> <div style="border: 1px solid black; padding: 2px 5px;">SHIFT</div> <div style="border: 1px solid black; padding: 2px 5px;">A₁</div> </div>	5.A
	<div style="border: 1px solid black; padding: 2px 5px;">ENTER</div>	n.L.
2. Key-in the maximum number in hex-code.	<div style="display: flex; justify-content: space-around; align-items: center;"> <div style="border: 1px solid black; padding: 2px 5px;">SHIFT</div> <div style="border: 1px solid black; padding: 2px 5px;">A₁</div> </div>	A
3. Store the maximum number.	<div style="border: 1px solid black; padding: 2px 5px;">ENTER</div>	5.A

6. SERVICE PROGRAMME DESCRIPTION cont.:

5.6 COPY OF INT. CH.'s FUNCTION CODE TO EEPROM

This programme is used to copy a function code table from the microcomputer into the EEPROM.

It should be noticed that the ENABLE CODE must specify the function code table for the international channels to be in the EEPROM. If not you cannot select this service programme.

The function code table can be selected among all the 16 country versions mentioned in this chapter section **5.1** . The content of these function

code tables can be found in chapter 10.

E.g. Copy the function code table for the German inland version (No. C) into the EEPROM.

1. Select service programme No. B.

Keyboard input	Read-out
SHIFT B ₂	5.6
ENTER	C.P.
SHIFT C ₃	C
ENTER	5.6

2. Key-in the country version number, in this case C.

3. Execute the copy procedure.

The display will be blank while the copy process is executed.

Now the function code table can be edited by means of service programme No. C.

6. SERVICE PROGRAMME DESCRIPTION cont.:



5.C

EDIT FUNCTION CODE TABLE IN EEPROM

When the ENABLE CODE specifies the function code table for all channels to be read from the EEPROM, this programme can be used to programme and/or edit the function code table found in the EEPROM.

Chapter 8 describes how to determine the function code.











The meaning of the two digit read-out is distinguished by means of the two LED-indicators 1W and TX.

When selected, the programme asks for the EDIT CHANNEL number and when entered it asks for the FUNCTION code for this channel. By using  

the actual function code will be displayed.

E.g. The function code table for the German inland version has been copied into the EEPROM by means of service programme no. B.

Now change ch. 67 to run with reduced output power, which means to change the function code from EC to EE.

	Keyboard input	Read-out
1. Select service programme No. C.	 	5.C
		1W E.C.
2. Key-in the channel number for which the function code must be changed,		1W 6
		1W 67
3. Store the channel number to be edited.		TX F.u.
4. Key-in the new function code for channel 67.	 	TX E
	 	TX EE
5. Store the new function code.		1W E.C.

Now a new channel can be selected; the change just made can be checked or the service programme can be left. If the service programme is left by 

, the number of the last selected service programme will be displayed

5.C

6. SERVICE PROGRAMME DESCRIPTION cont.:

5.d SELCALL ADJUSTMENT PROGRAMME

ATTENTION! This programme MUST NOT be selected if the enable code do not enable the selcall option.

If it should happen, the set must be switched off and on again, before further programming can proceed.

When a selcall unit has been repaired or adjusted, this programme should be used.

When selected, the microcomputer will generate an adjustment tone for the selcall AF-input.

At the same time the filter will be set up to the correct tone, ready for adjustment.

So the procedure will be as follows:

1. Make sure that the selcall unit is enabled by means of the enable code service programme No. 4.
2. Make sure that the selcall unit has been correctly installed.
3. Connect a DC-voltmeter to the detector output point on the selcall unit. Pin 2 on U04. Establish a short-circuit between the two non-common ends of resistors R26 (51 Kohm) and R40 (10 Kohm) (see page 1A).
4. Turn the volume potentiometer into its maximum position, fully clockwise.

5. Select service programme No. D.

6. Adjust potmeter R01 until maximum deflection is reached on the DC-meter.

7. Leave the service programme.

Keyboard input	Read-out
SHIFT D 4	5.d
ENTER	S.A.
	S.A.
SHIFT RETURN 9	5.d

Remove the DC-probe and the short-circuit between the two resistors, and now the selcall unit should be ready for use, if the selcall number is already programmed. If not select service programme No. E for programming of selcall number.

6. SERVICE PROGRAMME DESCRIPTION cont.:

5.E SELCALL/ATIS NUMBER PROGRAMMING

When a selcall or an ATIS option has been enabled - by means of the appropriate enable codes, this programme can be used to store the user number in the associated memory. Only one of the options must be enabled at a time when the programming is carried out.

The ATIS identity is a 10 digit number, where the 9 least significant digits have to be programmed. The format is as follows

Z M I D X1 X2 X3 X4 X5 X6

- Z Will always be the figure 9 and is hardcoded.
- MID Represents the Maritime Identification Digits for the appropriate country.
- X1..X6 Represents the converted ship callsign figures.

The identity number is programmed, digit by digit, with the most significant digit in the M I D -number entered first.

The selcall number is a 5 digit number, which has to be entered digit by digit.

If the number includes a sequence with two or more identical digits, it should be programmed with the repetition tone representing every second of these digits. I.e. the number 3 3 4 7 1 should be programmed 3 R 4 7 1.

The repetition tone is programmed as SHIFT B 2.

E.g. Programme the above selcall number.

1. Select service programme No. E.

2. Key-in the first digit in the number.

3. Store the first digit.

Keyboard input	Read-out
SHIFT E 5	5.E
ENTER	d.1
C 3	3
ENTER	d.2

6. SERVICE PROGRAMME DESCRIPTION cont.:

4. Key-in the second digit in the number. In this case the repetition tone should be programmed.

5. Store the second digit.

6. Key-in the third digit in the selcall number.

7. Store the third digit.

8. Key-in the fourth digit in the selcall number.

9. Store the fourth digit.

10. Key-in the last digit in the number.

11. Store the last digit.

Keyboard input	Read-out
SHIFT B 2	b
ENTER	d.3
D 4	4
ENTER	d.4
REVIEW 7	7
ENTER	d.5
A 1	1
ENTER	5.E

Now the number can be checked by entering the service programme again and

use the SHIFT REVIEW 7 function.

6. SERVICE PROGRAMME DESCRIPTION cont.:

5.F IDENTITY CODE PROGRAMMING

This programme can be used to select service mode on another RT2048, when connected to this set by means of a programming cable.

Programming cable:

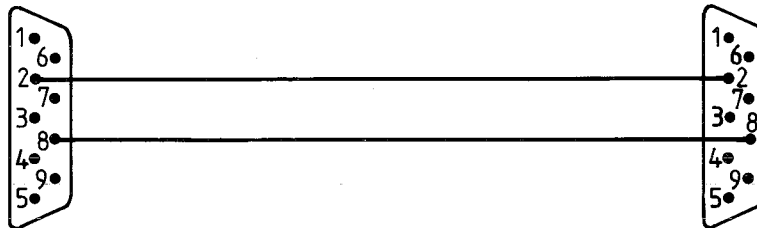

When this programme is selected, the read-out will be **E.S.** (enable service mode). Now press the button and the connected RT2048 will change to service mode; the read-out will be **L.S.** (leave service mode). When the wanted programming has been carried out on the connected RT2048, the button should be pressed on the set showing **L.S.**, and the connected RT2048 will leave service mode. Another RT2048 can be connected for programming or the service programme can be left by pressing .

7. MEMORY ALLOCATION TABLE

The programmable internal memory consisting of two EEPROM's, contains all the programmable information.

As mentioned in the general part, the memories are working with 16-bit word length. Because of the two digit read-out, the 16-bit word is divided into two 8-bit words, the High byte representing the 8 most significant bits and Low byte representing the 8 least significant bits.

When service programme No. 0 is used, the addresses can be programmed directly from the keyboard.

The content of the memory is organized as follows:

Address code in Hex- notation	High byte	Low byte
	7 6 5 4 3 2 1 0	7 6 5 4 3 2 1 0
	Function code for P-channels	Frequency code for P-channels
0	P0	P0
1	P1	P1
2	P2	P2
3	P3	P3
4	P4	P4
5	P5	P5
6	P6	P6
7	P7	P7
8	P8	P8
9	P9	P9
A	Quick channel number	D.W. preference ch. number
B	DSC/ATIS enable; AUXII code	Spare: Selcall No. digit 1
C	Selcall No. digit 2 and 3	Selcall No. digit 4 and 5
D	Bandshift code B _{TX} , B _{RX}	Synthesizer offset constant nP
E	Last selected channel No.	Spare
F	Enable code	Channel code; Country version
	Function code for A-channels	Frequency code for A-channels
10	A0	A0
19	A9	A9
	Function code for E-channels	Frequency code for E-channels
1A	E0	E0
23	E9	E9
	Function code for F-channels	Frequency code for F-channels
24	F0	F0
2D	F9	F9
2E	Transmitter base constant	Transmitter timer programming

7. MEMORY ALLOCATION TABLE cont.:

Address code in Hex-notation	High byte 7 6 5 4 3 2 1 0	Low byte 7 6 5 4 3 2 1 0
2F 30 3F	DSC-channel No. Must be FF Not in use "	Identity Code Not in use " "
40 46 47	Binary table containing the " Spare	user programmed scan-sequence Maximum No. of channels in scan sequence
48	Scan time in seconds in First digit	decimal notation Second digit
49 56 57 65 66 67 75 76 7B	Function code for all channel No. 2 Channel No. 28 Channel No. 61 Spare Channel No. 29 Channel No. 31 Channel No. 59 Channel No. 90 Channel No. 00	channels 00 -> 99 Channel No. 1 Channel No. 27 Channel No. 60 Channel No. 88 Spare Channel No. 30 Channel No. 58 Channel No. 89 Channel No. 99
7C 7F	Not in use " "	Not in use " "

RT2048 Service & Identity B

8. CHANNEL FUNCTION CODE GENERATION

All channels in the set are characterized by means of an 8-bit function code and an 8-bit frequency code.

This chapter describes how the function code is generated on the basis of the wishes to the channel performance.

When the 8-bit function code has been determined, it is split-up into two 4-bit words, which are translated into hexadecimal notation before programming.

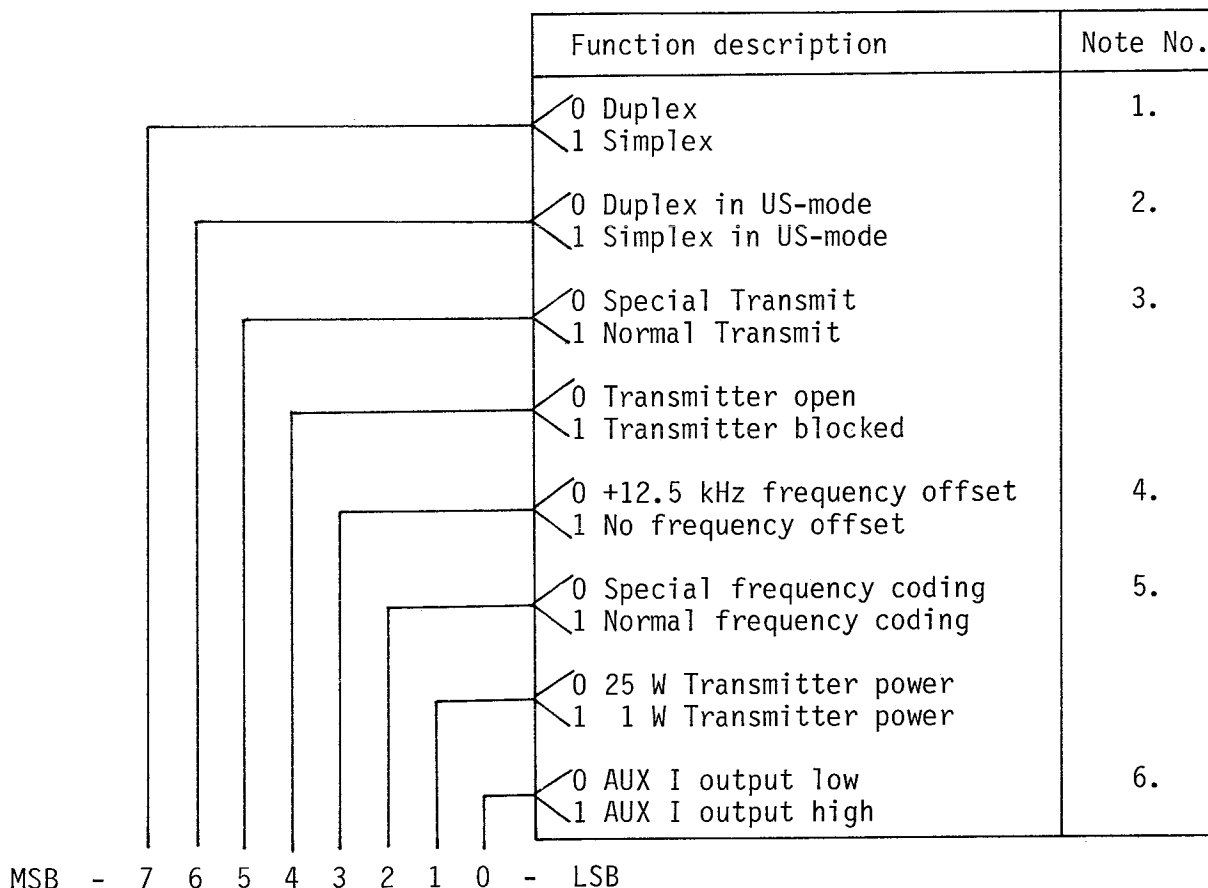

Notes:

1. When duplex is selected, the receiving frequency is increased with 4.6 MHz, compared to the normal simplex receiving frequency.
2. When duplex in US-mode is selected, the channel will run as a duplex channel when the set is in US-mode.
3. When Special Transmit is selected, the transmitter frequency is increased with 4.6 MHz compared to the normal transmitter frequency.
4. When using this bit, the normal transmit and receive frequency can be increased by 12.5 kHz.
5. This bit specifies whether special frequency coding is used. This means that the band-shift constants and receiver offset constants are used in the channel frequency coding. See chapter 9 for further details.
6. This bit specifies the logic output level of the AUX I port on the microcomputer. In conjunction with an option board it can be used e.g. to mute external equipment when a certain channel has been selected.

8. CHANNEL FUNCTION CODE GENERATION cont.:

Finally it should be noted, that a channel will be blocked on both transmitter and receiver when the function code equals 1 1 1 1 1 1 1 1, converted to hexadecimal notation FF.

Examples:

- A. A channel operating as a normal duplex channel both in normal mode and in US-mode, with no special frequency coding, 25W transmit power and a logic low at AUX I, would have the following binary function code (according to the table above) 0 0 1 0 1 1 0 0. Converted to the hex-code it equals 2C.
- B. Same as above, except that the channel will function as a simplex channel in US-mode. The binary code will be 0 1 1 0 1 1 0 0, equal to 6C in hex-code.
- C. A channel operating as a normal simplex channel both in normal mode and in US-mode with no special frequency coding, 1W transmit power and a logic low at AUX I, would have the function code 1 1 1 0 1 1 1 0, which converted to hex-code will be EE.
- D. Same as above, except that the receive and transmit frequency is increased by 12.5 kHz.
The binary code will be 1 1 1 0 0 1 1 0, equal to E6 in hex-code.

9. CHANNEL FREQUENCY CODE GENERATION (C1078A)

The frequency coding of a channel will normally consist of an 8-bit code, which should be programmed as a two digit hexadecimal number.

In special cases, where the set should operate with special duplex distances or operate below or above the basic frequency band, the frequency programming will include the programming of the two band-shift constants B_{TX} , B_{RX} and the transmitter base constant bP , and the receiver offset constant nP .

The basic frequency band for the transmitter operating in normal mode will be:

$$152,800 \text{ MHz} \leq f_{TX \text{ Normal}} \leq 159,150 \text{ MHz.}$$

By means of the channel function code, special transmit can be selected, resulting in the following frequency range:

$$157,400 \text{ MHz} \leq f_{TX \text{ Special}} \leq 163,750 \text{ MHz}$$

The normal transmit frequency can be determined by means of the following formula:

$$1. f_{TX \text{ Normal}} \text{ (MHz)} = 152,800 + M_{TX} \cdot 0,025 + B_{TX} \cdot 6,35 + bP \cdot 0.025 \text{ (MHz)}$$

where the transmitter bandshift constant $-2 \leq B_{TX} \leq +2$
and the transmitter frequency code (decimal) $0 \leq M_{TX} \leq 254$
and the transmitter base constant (decimal) $0 \leq bP \leq 254$.

In the basic frequency band $B_{TX} = 0$.

For the "fixed frequency" channels, ch's 00 -> 99 is the M_{TX} constants fixed and thus not programmable.

When the normal transmit frequency is specified for a private channel P0 - P9, A0 - A9, E0 - E9 or F0 - F9, the transmitter frequency code M_{TX} and the bandshift code B_{TX} can be determined by means of this formula (transmitter base constant $bP = 0$):

$$2. M_{TX} \text{ (in decimal)} = \frac{\frac{f_{TX \text{ Normal}} \text{ (MHz)} - 12224}{0,0125} - B_{TX} \cdot 254}{2}$$

B_{TX} should be selected to give a frequency code M_{TX} between 0 and 254.

Before programming, M_{TX} should be converted to a two digit hexadecimal number.

In the table below, $f_{TX \text{ Normal}}$ and M_{TX} is listed for the basic frequency band.

When the normal transmit frequency for the "fixed frequency" channels should be changed, it must be done by means of the transmitter base constant bP and B_{TX} . By the use of these two constants, the frequency band covered by the channels 00 -> 99 can be placed anywhere in the frequency range.

$$143,3 \text{ MHz} \leq f_{TX \text{ Normal ch. 00}} \leq 168,7 \text{ MHz.}$$

The relative frequency distance between the individual channels will still be the same.

9. CHANNEL FREQUENCY CODE GENERATION cont.:

This feature can only be used when the function code for the ch's 00-99 are placed in the EEPROM, and the function code specifies special frequency coding.

The basic frequency band for the receiver operating in simplex mode will be:

$$152,800 \text{ MHz} \leq f_{\text{Rx Simplex}} \leq 159,150 \text{ MHz.}$$

When operated in duplex mode, the frequency range for the receiver will be:

$$157,400 \text{ MHz} \leq f_{\text{Rx Duplex}} \leq 163,750 \text{ MHz.}$$

The receiving frequency in simplex mode can be determined by means of the following formula:

$$3. \quad f_{\text{Rx Simplex}} \text{ (MHz)} = f_{\text{Tx Normal}} + nP \cdot 0,025 + B_{\text{Rx}} \cdot 6,35 \text{ (MHz)}$$

where the receiver bandshift constant $-2 \leq B_{\text{Rx}} \leq 2$
and the receiver offset constant $0 \leq nP \leq 254$

For a normal simplex channel in the basic frequency band, both B_{Rx} and nP will equal 0.

When the normal transmit frequency and the simplex receiving frequency is specified, the receiver offset constant and the bandshift constant B_{Rx} can be determined by means of the following formula:

$$4. \quad nP \text{ (in decimal)} = \frac{f_{\text{Rx Simplex}} - f_{\text{Tx Normal}} \text{ (MHz)}}{0,0125} - B_{\text{Rx}} \cdot 254$$

B_{Rx} should be selected to give a receiver offset constant between 0 and 254.

Note! When either the bandshift constants B_{Tx} , B_{Rx} or the transmitter base constant bP or the receiver offset constant nP differs from 0, the channel function code **MUST** specify special frequency coding.

Note! In spite of the possibility of programming channels in a large frequency range (140,1 MHz to 171,85 MHz) and with large duplex distance, it **MUST** be remembered that there can be some physical constraints. The VCO tuning and adjustment range are limited by the components in the standard set. In the same way the fixed tuned buffer amplifiers will only operate properly in a limited frequency range, when no changes have been made.

Examples

A. Determine the necessary frequency coding to make a channel with $f_{\text{Tx Normal}} = 153,800 \text{ MHz}$ and $f_{\text{Rx Simplex}} = 154,800 \text{ MHz}$.

The transmitter frequency lies in the basic frequency band, so $B_{\text{Tx}} = 0$. The transmitter base constant is set to zero, $bP = 0$.

By use of formula 2 (or the table below) the transmitter frequency code M_{Tx} can be determined to be 40 in decimal, which converted to hex-code means 28.

Now B_{Rx} and nP can be determined by means of formula 4. When $f_{\text{Rx Simplex}} > f_{\text{Tx Normal}}$ and $f_{\text{Rx Simplex}} - f_{\text{Tx Normal}} < 6,35 \text{ (MHz)}$ the bandshift code $B_{\text{Rx}} = 0$, and nP can be determined to be 40 in decimal, converted to 28 in hex-code.

9. CHANNEL FREQUENCY CODE GENERATION cont.:







B. Programme the channel in A. to be a simplex channel both in normal mode and in U.S.-mode, with normal transmit running at 25 W power level and AUX I being logic high. The channel should lie in P0.

When using chapter 8, the channel function code can be determined to be E9 in hex-code.

1. Select service mode
2. Select service programme No. 7 for programming of private ch.'s P0 -> P9.
3. Enter the channel number to be programmed, P0.
4. Store the channel number.
5. Key-in the function code.
6. Store the function code.
7. Key-in the transmitter frequency code, M_{TX} , in this case 28.
8. Store the value of M_{TX} .
9. Leave this service programme.
10. Select service programme No. 9 for programming of bandshift code and receiver offset constant.

Keyboard input	Read-out
	5.7
REVIEW 7	5.7
ENTER	Ch.
	1W
SHIFT P 0	P
	1W
P 0	P0
	1W
ENTER	Fv.
	TX
SHIFT E 5	E
	TX
RETURN 9	E9
	TX
ENTER	Fv.
	US
B 2	2
	US
8	28
	US
ENTER	Ch.
	1W
SHIFT RETURN 9	5.7
RETURN 9	5.9
ENTER	bc.
	TX

9. CHANNEL FREQUENCY CODE GENERATION cont.:

	Keyboard input	Read-out
11. Key-in the bandshift code, in this case both B_{RX} and B_{TX} equal 0.		00 1W
12. Store the bandshift code.		$6P.$ TX
13. Key-in the transmitter base constant. In this case 0.		00 TX
14. Store the transmitter base constant.		$nP.$ US
15. Key-in the receiver offset constant, in this case 28.		02 US
		28 US
16. Store the receiver offset constant.		5.9

Leave service mode and check the channel by means of an RF-counter and a signal generator.

- C. Determine the needed frequency coding to generate a channel operating with $f_{TX \text{ Normal}} = 152,000 \text{ MHz}$ and $f_{RX \text{ Simplex}} = 152,000 \text{ MHz}$.

The transmitter frequency lies below the basic frequency band and $152,8 - f_{TX \text{ Normal}} < 6,35 \text{ MHz}$, so the transmitter bandshift constant should be -1 .

When using formula 2, the transmitter frequency code can be determined by $B_{TX} = -1$.

The calculation ends with $M_{TX} = 222$ in decimal, which converted to hex-code equals DE.

The receiver frequency in simplex mode equals the normal transmitter frequency, so both B_{RX} and nP must be 0.

The table below lists the frequency code for normal transmitting frequencies in the basic frequency range.

9. CHANNEL FREQUENCY CODE GENERATION cont.:

fTx Normal MHz	M _{Tx} in Hex-code	fTx Normal MHz	M _{Tx} in Hex-code
152,800	00	156,025	81
152,825	01	156,050	82
152,850	02	156,075	83
152,875	03	156,100	84
152,900	04	156,125	85
152,925	05	156,150	86
152,950	06	156,175	87
152,975	07	156,200	88
153,000	08	156,225	89
153,025	09	156,250	8A
153,050	0A	156,275	8B
153,075	0B	156,300	8C
153,100	0C	156,325	8D
153,125	0D	156,350	8E
153,150	0E	156,375	8F
153,175	0F	156,400	90
153,200	10	156,425	91
153,225	11	156,450	92
153,250	12	156,475	93
153,275	13	156,500	94
153,300	14	156,525	95
153,325	15	156,550	96
153,350	16	156,575	97
153,375	17	156,600	98
153,400	18	156,625	99
153,425	19	156,650	9A
153,450	1A	156,675	9B
153,475	1B	156,700	9C
153,500	1C	156,725	9D
153,525	1D	156,750	9E
153,550	1E	156,775	9F
153,575	1F	156,800	A0
153,600	20	156,825	A1
153,625	21	156,850	A2
153,650	22	156,875	A3
153,675	23	156,900	A4
153,700	24	156,925	A5
153,725	25	156,950	A6
153,750	26	156,975	A7
153,775	27	157,000	A8
153,800	28	157,025	A9
153,825	29	157,050	AA
153,850	2A	157,075	AB
153,875	2B	157,100	AC
153,900	2C	157,125	AD
153,925	2D	157,150	AE
153,950	2E	157,175	AF
153,975	2F	157,200	B0
154,000	30	157,225	B1
154,025	31	157,250	B2
154,050	32	157,275	B3
154,075	33	157,300	B4
154,100	34	157,325	B5
154,125	35	157,350	B6

RT2048 Service & Identity

9. CHANNEL FREQUENCY CODE GENERATION cont.:

f _{Tx} Normal MHz	M _{Tx} in Hex-code	f _{Tx} Normal MHz	M _{Tx} in Hex-code
154,150	36	157,375	B7
154,175	37	157,400	B8
154,200	38	157,425	B9
154,225	39	157,450	BA
154,250	3A	157,475	BB
154,275	3B	157,500	BC
154,300	3C	157,525	BD
154,325	3D	157,550	BE
154,350	3E	157,575	BF
154,375	3F	157,600	C0
154,400	40	157,625	C1
154,425	41	157,650	C2
154,450	42	157,675	C3
154,475	43	157,700	C4
154,500	44	157,725	C5
154,525	45	157,750	C6
154,550	46	157,775	C7
154,575	47	157,800	C8
154,600	48	157,825	C9
154,625	49	157,850	CA
154,650	4A	157,875	CB
154,675	4B	157,900	CC
154,700	4C	157,925	CD
154,725	4D	157,950	CE
154,750	4E	157,975	CF
154,775	4F	158,000	D0
154,800	50	158,025	D1
154,825	51	158,050	D2
154,850	52	158,075	D3
154,875	53	158,100	D4
154,900	54	158,125	D5
154,925	55	158,150	D6
154,950	56	158,175	D7
154,975	57	158,200	D8
155,000	58	158,225	D9
155,025	59	158,250	DA
155,050	5A	158,275	DB
155,075	5B	158,300	DC
155,100	5C	158,325	DD
155,125	5D	158,350	DE
155,150	5E	158,375	DF
155,175	5F	158,400	E0
155,200	60	158,425	E1
155,225	61	158,450	E2
155,250	62	158,475	E3
155,275	63	158,500	E4
155,300	64	158,525	E5
155,325	65	158,550	E6
155,350	66	158,575	E7
155,375	67	158,600	E8
155,400	68	158,625	E9
155,425	69	158,650	EA

RT2048 Service & Identity

9. CHANNEL FREQUENCY CODE GENERATION cont.:

f _{Tx} Normal MHz	M _{Tx} in Hex-code	f _{Tx} Normal MHz	M _{Tx} in Hex-code
155,450	6A	158,675	EB
155,475	6B	158,700	EC
155,500	6C	158,725	ED
155,525	6D	158,750	EE
155,550	6E	158,775	EF
155,575	6F	158,800	F0
155,600	70	158,825	F1
155,625	71	158,850	F2
155,650	72	158,875	F3
155,675	73	158,900	F4
155,700	74	158,925	F5
155,725	75	158,950	F6
155,750	76	158,975	F7
155,775	77	159,000	F8
155,800	78	159,025	F9
155,825	79	159,050	FA
155,850	7A	159,075	FB
155,875	7B	159,100	FC
155,900	7C	159,125	FD
155,925	7D	159,150	FE
155,950	7E		
155,975	7F		
156,000	80		

RT2048 Service & Identity

10. COUNTRY VERSION FUNCTION CODE TABLES

Country Vers. Code 0		Country Vers.: Standard international		
Channel No.	Normal Frequency MHz	Transmitter Frequency Code		Function Code in Hex. Number
		Ndec.	Hex	
00		255	FF	FF
01	156.050	130	82	6C
02	156.100	132	84	2C
03	156.150	134	86	2C
04	156.200	136	88	2C
05	156.250	138	8A	6C
06	156.300	140	8C	EC
07	156.350	142	8E	6C
08	156.400	144	90	EC
09	156.450	146	92	EC
10	156.500	148	94	EC
11	156.550	150	96	EC
12	156.600	152	98	EC
13	156.650	154	9A	EC
14	156.700	156	9C	EC
15	156.750	158	9E	EC
16	156.800	160	A0	EC
17	156.850	162	A2	EC
18	156.900	164	A4	6C
19	156.950	166	A6	6C
20	157.000	168	A8	2C
21	157.050	170	AA	6C
22	157.100	172	AC	6C
23	157.150	174	AE	6C
24	157.200	176	B0	2C
25	157.250	178	B2	2C
26	157.300	180	B4	2C
27	157.350	182	B6	2C
28	157.400	184	B8	2C
29		255	FF	FF
60	156.025	129	81	2C
61	156.075	131	83	2C
62	156.125	133	85	2C
63	156.175	135	87	6C
64	156.225	137	89	2C
65	156.275	139	8B	6C
66	156.325	141	8D	6C
67	156.375	143	8F	EC
68	156.425	145	91	EC
69	156.475	147	93	EC
70	156.525	149	95	EC
71	156.575	151	97	EC
72	156.625	153	99	EC
73	156.675	155	9B	EC
74	156.725	157	9D	EC
75	156.775	159	9F	EE
76	156.825	161	A1	EE
77	156.875	163	A3	EC
78	156.925	165	A5	6C
79	156.975	167	A7	6C
80	157.025	169	A9	6C
81	157.075	171	AB	6C
82	157.125	173	AD	6C
83	157.175	175	AF	6C
84	157.225	177	B1	2C
85	157.275	179	B3	2C
86	157.325	181	B5	2C
87	157.375	183	B7	2C
88	157.425	185	B9	6C
89		255	FF	FF
Private ch.				

10. COUNTRY VERSION FUNCTION CODE TABLES cont.:

Country Vers. Code 1		Country Vers.: Standard w. pleasure boat ch's DK		
Channel No.	Normal Frequency MHz	Transmitter Frequency Code		Function Code in Hex. Number
		Ndec.	Hex	
00		255	FF	FF
01	156.050	130	82	6C
02	156.100	132	84	2C
03	156.150	134	86	2C
04	156.200	136	88	2C
05	156.250	138	8A	6C
06	156.300	140	8C	EC
07	156.350	142	8E	6C
08	156.400	144	90	EC
09	156.450	146	92	EC
10	156.500	148	94	EC
11	156.550	150	96	EC
12	156.600	152	98	EC
13	156.650	154	9A	EC
14	156.700	156	9C	EC
15	156.750	158	9E	EC
16	156.800	160	A0	EC
17	156.850	162	A2	EC
18	156.900	164	A4	6C
19	156.950	166	A6	6C
20	157.000	168	A8	2C
21	157.050	170	AA	6C
22	157.100	172	AC	6C
23	157.150	174	AE	6C
24	157.200	176	B0	2C
25	157.250	178	B2	2C
26	157.300	180	B4	2C
27	157.350	182	B6	2C
28	157.400	184	B8	2C
29		255	FF	FF
60	156.025	129	81	2C
61	156.075	131	83	2C
62	156.125	133	85	2C
63	156.175	135	87	6C
64	156.225	137	89	2C
65	156.275	139	8B	6C
66	156.325	141	8D	6C
67	156.375	143	8F	EC
68	156.425	145	91	EC
69	156.475	147	93	EC
70	156.525	149	95	EC
71	156.575	151	97	EC
72	156.625	153	99	EC
73	156.675	155	9B	EC
74	156.725	157	9D	EC
75	156.775	159	9F	EE
76	156.825	161	A1	EE
77	156.875	163	A3	EC
78	156.925	165	A5	6C
79	156.975	167	A7	6C
80	157.025	169	A9	6C
81	157.075	171	AB	6C
82	157.125	173	AD	6C
83	157.175	175	AF	6C
84	157.225	177	B1	2C
85	157.275	179	B3	2C
86	157.325	181	B5	2C
87	157.375	183	B7	2C
88	157.425	185	B9	6C
89		255	FF	FF
Private ch.				
P3 - 1L	155.500	108	6C	EC
P4 - 2L	155.525	109	6D	EC

10. COUNTRY VERSION FUNCTION CODE TABLES cont.:

Country Vers. Code 2		Country Vers.: Standard w. pleasure boat ch's N		
Channel No.	Normal Frequency MHz	Transmitter Frequency Code		Function Code in Hex. Number
		Ndec.	Hex	
00		255	FF	FF
01	156.050	130	82	6C
02	156.100	132	84	2C
03	156.150	134	86	2C
04	156.200	136	88	2C
05	156.250	138	8A	6C
06	156.300	140	8C	EC
07	156.350	142	8E	6C
08	156.400	144	90	EC
09	156.450	146	92	EC
10	156.500	148	94	EC
11	156.550	150	96	EC
12	156.600	152	98	EC
13	156.650	154	9A	EC
14	156.700	156	9C	EC
15	156.750	158	9E	EC
16	156.800	160	A0	EC
17	156.850	162	A2	EC
18	156.900	164	A4	6C
19	156.950	166	A6	6C
20	157.000	168	A8	2C
21	157.050	170	AA	6C
22	157.100	172	AC	6C
23	157.150	174	AE	6C
24	157.200	176	B0	2C
25	157.250	178	B2	2C
26	157.300	180	B4	2C
27	157.350	182	B6	2C
28	157.400	184	B8	2C
29		255	FF	FF
60	156.025	129	81	2C
61	156.075	131	83	2C
62	156.125	133	85	2C
63	156.175	135	87	6C
64	156.225	137	89	2C
65	156.275	139	8B	6C
66	156.325	141	8D	6C
67	156.375	143	8F	EC
68	156.425	145	91	EC
69	156.475	147	93	EC
70	156.525	149	95	EC
71	156.575	151	97	EC
72	156.625	153	99	EC
73	156.675	155	9B	EC
74	156.725	157	9D	EC
75	156.775	159	9F	EE
76	156.825	161	A1	EE
77	156.875	163	A3	EC
78	156.925	165	A5	6C
79	156.975	167	A7	6C
80	157.025	169	A9	6C
81	157.075	171	AB	6C
82	157.125	173	AD	6C
83	157.175	175	AF	6C
84	157.225	177	B1	2C
85	157.275	179	B3	2C
86	157.325	181	B5	2C
87	157.375	183	B7	2C
88	157.425	185	B9	6C
89		255	FF	FF
Private ch.				
P1 - L1	155.500	108	6C	EC
P2 - L2	155.525	109	6D	EC
P3 - L3	155.650	114	72	EC

10. COUNTRY VERSION FUNCTION CODE TABLES cont.:

Country Vers. Code 3		Country Vers.: Standard w. fishing channels		
Channel No.	Normal Frequency MHz	Transmitter Frequency Code		Function Code in Hex. Number
		Ndec.	Hex	
00		255	FF	FF
01	156.050	130	82	6C
02	156.100	132	84	2C
03	156.150	134	86	2C
04	156.200	136	88	2C
05	156.250	138	8A	6C
06	156.300	140	8C	EC
07	156.350	142	8E	6C
08	156.400	144	90	EC
09	156.450	146	92	EC
10	156.500	148	94	EC
11	156.550	150	96	EC
12	156.600	152	98	EC
13	156.650	154	9A	EC
14	156.700	156	9C	EC
15	156.750	158	9E	EC
16	156.800	160	A0	EC
17	156.850	162	A2	EC
18	156.900	164	A4	6C
19	156.950	166	A6	6C
20	157.000	168	A8	2C
21	157.050	170	AA	6C
22	157.100	172	AC	6C
23	157.150	174	AE	6C
24	157.200	176	B0	2C
25	157.250	178	B2	2C
26	157.300	180	B4	2C
27	157.350	182	B6	2C
28	157.400	184	B8	2C
29		255	FF	FF
60	156.025	129	81	2C
61	156.075	131	83	2C
62	156.125	133	85	2C
63	156.175	135	87	6C
64	156.225	137	89	2C
65	156.275	139	8B	6C
66	156.325	141	8D	6C
67	156.375	143	8F	EC
68	156.425	145	91	EC
69	156.475	147	93	EC
70	156.525	149	95	EC
71	156.575	151	97	EC
72	156.625	153	99	EC
73	156.675	155	9B	EC
74	156.725	157	9D	EC
75	156.775	159	9F	EE
76	156.825	161	A1	EE
77	156.875	163	A3	EC
78	156.925	165	A5	6C
79	156.975	167	A7	6C
80	157.025	169	A9	6C
81	157.075	171	AB	6C
82	157.125	173	AD	6C
83	157.175	175	AF	6C
84	157.225	177	B1	2C
85	157.275	179	B3	2C
86	157.325	181	B5	2C
87	157.375	183	B7	2C
88	157.425	185	B9	6C
89		255	FF	FF
Private ch. P1 - F1	155.625	113	71	EC
P2 - F2	155.775	119	77	EC
P3 - F3	155.825	121	79	EC

10. COUNTRY VERSION FUNCTION CODE TABLES cont.:

Country Vers. Code 4		Country Vers.: Standard w. weather channels		
Channel No.	Normal Frequency MHz	Transmitter Frequency Code		Function Code in Hex. Number
		Ndec.	Hex	
00		255	FF	FF
01	156.050	130	82	6C
02	156.100	132	84	2C
03	156.150	134	86	2C
04	156.200	136	88	2C
05	156.250	138	8A	6C
06	156.300	140	8C	EC
07	156.350	142	8E	6C
08	156.400	144	90	EC
09	156.450	146	92	EC
10	156.500	148	94	EC
11	156.550	150	96	EC
12	156.600	152	98	EC
13	156.650	154	9A	EC
14	156.700	156	9C	EC
15	156.750	158	9E	EC
16	156.800	160	A0	EC
17	156.850	162	A2	EC
18	156.900	164	A4	6C
19	156.950	166	A6	6C
20	157.000	168	A8	2C
21	157.050	170	AA	6C
22	157.100	172	AC	6C
23	157.150	174	AE	6C
24	157.200	176	B0	2C
25	157.250	178	B2	2C
26	157.300	180	B4	2C
27	157.350	182	B6	2C
28	157.400	184	B8	2C
29		255	FF	FF
60	156.025	129	81	2C
61	156.075	131	83	2C
62	156.125	133	85	2C
63	156.175	135	87	6C
64	156.225	137	89	2C
65	156.275	139	8B	6C
66	156.325	141	8D	6C
67	156.375	143	8F	EC
68	156.425	145	91	EC
69	156.475	147	93	EC
70	156.525	149	95	EC
71	156.575	151	97	EC
72	156.625	153	99	EC
73	156.675	155	9B	EC
74	156.725	157	9D	EC
75	156.775	159	9F	EE
76	156.825	161	A1	EE
77	156.875	163	A3	EC
78	156.925	165	A5	6C
79	156.975	167	A7	6C
80	157.025	169	A9	6C
81	157.075	171	AB	6C
82	157.125	173	AD	6C
83	157.175	175	AF	6C
84	157.225	177	B1	2C
85	157.275	179	B3	2C
86	157.325	181	B5	2C
87	157.375	183	B7	2C
88	157.425	185	B9	6C
89		255	FF	FF
Private ch. P1 - WX1	157.950	206	CE	3C
P2 - WX2	157.800	200	C8	3C
P3 - WX3	157.875	203	CB	3C
P4 - WX4	157.050	170	AA	3C

10. COUNTRY VERSION FUNCTION CODE TABLES cont.:

Country Vers. Code 5		Country Vers.: Standard w. 22A		
Channel No.	Normal Frequency MHz	Transmitter Frequency Code		Function Code in Hex. Number
		Ndec.	Hex	
00		255	FF	FF
01	156.050	130	82	6C
02	156.100	132	84	2C
03	156.150	134	86	2C
04	156.200	136	88	2C
05	156.250	138	8A	6C
06	156.300	140	8C	EC
07	156.350	142	8E	6C
08	156.400	144	90	EC
09	156.450	146	92	EC
10	156.500	148	94	EC
11	156.550	150	96	EC
12	156.600	152	98	EC
13	156.650	154	9A	EC
14	156.700	156	9C	EC
15	156.750	158	9E	EC
16	156.800	160	A0	EC
17	156.850	162	A2	EC
18	156.900	164	A4	6C
19	156.950	166	A6	6C
20	157.000	168	A8	2C
21	157.050	170	AA	6C
22	157.100	172	AC	6C
23	157.150	174	AE	6C
24	157.200	176	B0	2C
25	157.250	178	B2	2C
26	157.300	180	B4	2C
27	157.350	182	B6	2C
28	157.400	184	B8	2C
29		255	FF	FF
60	156.025	129	81	2C
61	156.075	131	83	2C
62	156.125	133	85	2C
63	156.175	135	87	6C
64	156.225	137	89	2C
65	156.275	139	8B	6C
66	156.325	141	8D	6C
67	156.375	143	8F	EC
68	156.425	145	91	EC
69	156.475	147	93	EC
70	156.525	149	95	EC
71	156.575	151	97	EC
72	156.625	153	99	EC
73	156.675	155	9B	EC
74	156.725	157	9D	EC
75	156.775	159	9F	EE
76	156.825	161	A1	EE
77	156.875	163	A3	EC
78	156.925	165	A5	6C
79	156.975	167	A7	6C
80	157.025	169	A9	6C
81	157.075	171	AB	6C
82	157.125	173	AD	6C
83	157.175	175	AF	6C
84	157.225	177	B1	2C
85	157.275	179	B3	2C
86	157.325	181	B5	2C
87	157.375	183	B7	2C
88	157.425	185	B9	6C
89		255	FF	FF
Private ch. P0 - 22A	157.100	172	AC	EC

10. COUNTRY VERSION FUNCTION CODE TABLES cont.:

Country Vers. Code 6		Country Vers.: Standard w. weather channels and 22A		
Channel No.	Normal Frequency MHz	Transmitter Frequency Code		Function Code in Hex. Number
		Ndec.	Hex	
00		255	FF	FF
01	156.050	130	82	6C
02	156.100	132	84	2C
03	156.150	134	86	2C
04	156.200	136	88	2C
05	156.250	138	8A	6C
06	156.300	140	8C	EC
07	156.350	142	8E	6C
08	156.400	144	90	EC
09	156.450	146	92	EC
10	156.500	148	94	EC
11	156.550	150	96	EC
12	156.600	152	98	EC
13	156.650	154	9A	EC
14	156.700	156	9C	EC
15	156.750	158	9E	EC
16	156.800	160	A0	EC
17	156.850	162	A2	EC
18	156.900	164	A4	6C
19	156.950	166	A6	6C
20	157.000	168	A8	2C
21	157.050	170	AA	6C
22	157.100	172	AC	6C
23	157.150	174	AE	6C
24	157.200	176	B0	2C
25	157.250	178	B2	2C
26	157.300	180	B4	2C
27	157.350	182	B6	2C
28	157.400	184	B8	2C
29		255	FF	FF
60	156.025	129	81	2C
61	156.075	131	83	2C
62	156.125	133	85	2C
63	156.175	135	87	6C
64	156.225	137	89	2C
65	156.275	139	8B	6C
66	156.325	141	8D	6C
67	156.375	143	8F	EC
68	156.425	145	91	EC
69	156.475	147	93	EC
70	156.525	149	95	EC
71	156.575	151	97	EC
72	156.625	153	99	EC
73	156.675	155	9B	EC
74	156.725	157	9D	EC
75	156.775	159	9F	EE
76	156.825	161	A1	EE
77	156.875	163	A3	EC
78	156.925	165	A5	6C
79	156.975	167	A7	6C
80	157.025	169	A9	6C
81	157.075	171	AB	6C
82	157.125	173	AD	6C
83	157.175	175	AF	6C
84	157.225	177	B1	2C
85	157.275	179	B3	2C
86	157.325	181	B5	2C
87	157.375	183	B7	2C
88	157.425	185	B9	6C
89		255	FF	FF
Private ch.				
P0 - 22A	157.100	172	AC	EC
P1 - WX1	157.950	206	CE	3C
P2 - WX2	157.800	200	C8	3C
P3 - WX3	157.875	203	CB	3C
P4 - WX4	157.050	170	AA	3C

10. COUNTRY VERSION FUNCTION CODE TABLES cont.:

Country Vers. Code 7		Country Vers.: Standard w. ch. 37		
Channel No.	Normal Frequency MHz	Transmitter Frequency Code		Function Code in Hex. Number
		Ndec.	Hex	
00		255	FF	FF
01	156.050	130	82	6C
02	156.100	132	84	2C
03	156.150	134	86	2C
04	156.200	136	88	2C
05	156.250	138	8A	6C
06	156.300	140	8C	EC
07	156.350	142	8E	6C
08	156.400	144	90	EC
09	156.450	146	92	EC
10	156.500	148	94	EC
11	156.550	150	96	EC
12	156.600	152	98	EC
13	156.650	154	9A	EC
14	156.700	156	9C	EC
15	156.750	158	9E	EC
16	156.800	160	A0	EC
17	156.850	162	A2	EC
18	156.900	164	A4	6C
19	156.950	166	A6	6C
20	157.000	168	A8	2C
21	157.050	170	AA	6C
22	157.100	172	AC	6C
23	157.150	174	AE	6C
24	157.200	176	B0	2C
25	157.250	178	B2	2C
26	157.300	180	B4	2C
27	157.350	182	B6	2C
28	157.400	184	B8	2C
29		255	FF	FF
60	156.025	129	81	2C
61	156.075	131	83	2C
62	156.125	133	85	2C
63	156.175	135	87	6C
64	156.225	137	89	2C
65	156.275	139	8B	6C
66	156.325	141	8D	6C
67	156.375	143	8F	EC
68	156.425	145	91	EC
69	156.475	147	93	EC
70	156.525	149	95	EC
71	156.575	151	97	EC
72	156.625	153	99	EC
73	156.675	155	9B	EC
74	156.725	157	9D	EC
75	156.775	159	9F	EE
76	156.825	161	A1	EE
77	156.875	163	A3	EC
78	156.925	165	A5	6C
79	156.975	167	A7	6C
80	157.025	169	A9	6C
81	157.075	171	AB	6C
82	157.125	173	AD	6C
83	157.175	175	AF	6C
84	157.225	177	B1	2C
85	157.275	179	B3	2C
86	157.325	181	B5	2C
87	157.375	183	B7	2C
88	157.425	185	B9	6C
89		255	FF	FF
Private ch.				
P1 - 37	157.850	202	CA	EC

10. COUNTRY VERSION FUNCTION CODE TABLES cont.:

Country Vers. Code 8		Country Vers.: Standard		
Channel No.	Normal Frequency MHz	Transmitter Frequency Code		Function Code in Hex. Number
		Ndec.	Hex	
00		255	FF	FF
01	156.050	130	82	6C
02	156.100	132	84	2C
03	156.150	134	86	2C
04	156.200	136	88	2C
05	156.250	138	8A	6C
06	156.300	140	8C	EC
07	156.350	142	8E	6C
08	156.400	144	90	EC
09	156.450	146	92	EC
10	156.500	148	94	EC
11	156.550	150	96	EC
12	156.600	152	98	EC
13	156.650	154	9A	EC
14	156.700	156	9C	EC
15	156.750	158	9E	EC
16	156.800	160	A0	EC
17	156.850	162	A2	EC
18	156.900	164	A4	6C
19	156.950	166	A6	6C
20	157.000	168	A8	2C
21	157.050	170	AA	6C
22	157.100	172	AC	6C
23	157.150	174	AE	6C
24	157.200	176	B0	2C
25	157.250	178	B2	2C
26	157.300	180	B4	2C
27	157.350	182	B6	2C
28	157.400	184	B8	2C
29		255	FF	FF
60	156.025	129	81	2C
61	156.075	131	83	2C
62	156.125	133	85	2C
63	156.175	135	87	6C
64	156.225	137	89	2C
65	156.275	139	8B	6C
66	156.325	141	8D	6C
67	156.375	143	8F	EC
68	156.425	145	91	EC
69	156.475	147	93	EC
70	156.525	149	95	EC
71	156.575	151	97	EC
72	156.625	153	99	EC
73	156.675	155	9B	EC
74	156.725	157	9D	EC
75	156.775	159	9F	EE
76	156.825	161	A1	EE
77	156.875	163	A3	EC
78	156.925	165	A5	6C
79	156.975	167	A7	6C
80	157.025	169	A9	6C
81	157.075	171	AB	6C
82	157.125	173	AD	6C
83	157.175	175	AF	6C
84	157.225	177	B1	2C
85	157.275	179	B3	2C
86	157.325	181	B5	2C
87	157.375	183	B7	2C
88	157.425	185	B9	6C
89		255	FF	FF
Private ch.				

10. COUNTRY VERSION FUNCTION CODE TABLES cont.:

Country Vers. Code 9		Country Vers.: Ch. 00 -> 99 all simplex					
Channel No.	Normal Transmitting		Channel No.	Normal Transmitting		Function Code in Hex. Number	
	Frequency MHz	Frequency Code Ndec. Hex		Frequency MHz	Frequency Code Ndec. Hex		
00	156.000	128 80	50	158.500	228 E4		
01	156.050	130 82	51	158.550	230 E6		
02	156.100	132 84	52	158.600	232 E8		
03	156.150	134 86	53	158.650	234 EA		
04	156.200	136 88	54	158.700	236 EC		
05	156.250	138 8A	55	158.750	238 EE		
06	156.300	140 8C	56	158.800	240 F0		
07	156.350	142 8E	57	158.850	242 F2		
08	156.400	144 90	58	158.900	244 F4		
09	156.450	146 92	59	158.950	246 F6		
10	156.500	148 94	60	156.025	129 81		
11	156.550	150 96	61	156.075	131 83		
12	156.600	152 98	62	156.125	133 85		
13	156.650	154 9A	63	156.175	135 87		
14	156.700	156 9C	64	156.225	137 89		
15	156.750	158 9E	65	156.275	139 8B		
16	156.800	160 A0	66	156.325	141 8D		
17	156.850	162 A2	67	156.375	143 8F		
18	156.900	164 A4	68	156.425	145 91		
19	156.950	166 A6	69	156.475	147 93		
20	157.000	168 A8	70	156.525	149 95		
21	157.050	170 AA	71	156.575	151 97		
22	157.100	172 AC	72	156.625	153 99		
23	157.150	174 AE	73	156.675	155 9B		
24	157.200	176 B0	74	156.725	157 9D		
25	157.250	178 B2	75	156.775	159 9F		
26	157.300	180 B4	76	156.825	161 A1		
27	157.350	182 B6	77	156.875	163 A3		
28	157.400	184 B8	78	156.925	165 A5		
29	157.450	186 BA	79	156.975	167 A7		
30	157.500	188 BC	80	157.025	169 A9		
31	157.550	190 BE	81	157.075	171 AB		
32	157.600	192 C0	82	157.125	173 AD		
33	157.650	194 C2	83	157.175	175 AF		
34	157.700	196 C4	84	157.225	177 B1		
35	157.750	198 C6	85	157.275	179 B3		
36	157.800	200 C8	86	157.325	181 B5		
37	157.850	202 CA	87	157.375	183 B7		
38	157.900	204 CC	88	157.425	185 B9		
39	157.950	206 CE	89	157.475	187 BB		
40	158.000	208 D0	90	157.525	189 BD		
41	158.050	210 D2	91	157.575	191 BF		
42	158.100	212 D4	92	157.625	193 C1		
43	158.150	214 D6	93	157.675	195 C3		
44	158.200	216 D8	94	157.725	197 C5		
45	158.250	218 DA	95	157.775	199 C7		
46	158.300	220 DC	96	157.825	201 C9		
47	158.350	222 DE	97	157.875	203 CB		
48	158.400	224 E0	98	157.925	205 CD		
49	158.450	226 E2	99	157.975	207 CF		

10. COUNTRY VERSION FUNCTION CODE TABLES cont.:

Country Vers. Code A		Country Vers.: Belgium, inland			
Channel No.	Normal Transmitter		Function Code in Hex. Number		
	Frequency MHz	Frequency Code Ndec. Hex			
00		255 FF	FF		
01	156.050	130 82	6E		
02	156.100	132 84	2E		
03	156.150	134 86	2E		
04	156.200	136 88	2E		
05	156.250	138 8A	6E		
06	156.300	140 8C	EE		
07	156.350	142 8E	6C		
08	156.400	144 90	EE		
09	156.450	146 92	EE		
10	156.500	148 94	EE		
11	156.550	150 96	EE		
12	156.600	152 98	EE		
13	156.650	154 9A	EE		
14	156.700	156 9C	EE		
15	156.750	158 9E	EE		
16	156.800	160 A0	EC		
17	156.850	162 A2	EE		
18	156.900	164 A4	6E		
19	156.950	166 A6	6E		
20	157.000	168 A8	2E		
21	157.050	170 AA	6E		
22	157.100	172 AC	6E		
23	157.150	174 AE	6C		
24	157.200	176 B0	2C		
25	157.250	178 B2	2C		
26	157.300	180 B4	2C		
27	157.350	182 B6	2C		
28	157.400	184 B8	2C		
29		255 FF	FF		
60	156.025	129 81	2E		
61	156.075	131 83	2E		
62	156.125	133 85	2E		
63	156.175	135 87	6E		
64	156.225	137 89	2E		
65	156.275	139 8B	6E		
66	156.325	141 8D	6E		
67	156.375	143 8F	EE		
68	156.425	145 91	EE		
69	156.475	147 93	EE		
70	156.525	149 95	EE		
71	156.575	151 97	EE		
72	156.625	153 99	EE		
73	156.675	155 9B	EE		
74	156.725	157 9D	EE		
75	156.775	159 9F	EE		
76	156.825	161 A1	EE		
77	156.875	163 A3	EE		
78	156.925	165 A5	6C		
79	156.975	167 A7	6E		
80	157.025	169 A9	6E		
81	157.075	171 AB	6C		
82	157.125	173 AD	6C		
83	157.175	175 AF	6C		
84	157.225	177 B1	2C		
85	157.275	179 B3	2C		
86	157.325	181 B5	2C		
87	157.375	183 B7	2C		
88	157.425	185 B9	6C		
89		255 FF	FF		
Private ch.					

10. COUNTRY VERSION FUNCTION CODE TABLES cont.:

Country Vers. Code B		Country Vers.: France, inland		
Channel No.	Normal Transmitter Frequency MHz	Frequency Code		Function Code in Hex. Number
		Ndec.	Hex	
00		255	FF	FF
01	156.050	130	82	6C
02	156.100	132	84	2C
03	156.150	134	86	2C
04	156.200	136	88	2C
05	156.250	138	8A	6C
06	156.300	140	8C	EE
07	156.350	142	8E	6C
08	156.400	144	90	EC
09	156.450	146	92	EC
10	156.500	148	94	EE
11	156.550	150	96	EE
12	156.600	152	98	EE
13	156.650	154	9A	EE
14	156.700	156	9C	EE
15	156.750	158	9E	EE
16	156.800	160	A0	EC
17	156.850	162	A2	EE
18	156.900	164	A4	6C
19	156.950	166	A6	6C
20	157.000	168	A8	2C
21	157.050	170	AA	6C
22	157.100	172	AC	6C
23	157.150	174	AE	6C
24	157.200	176	B0	2C
25	157.250	178	B2	2C
26	157.300	180	B4	2C
27	157.350	182	B6	2C
28	157.400	184	B8	2C
29		255	FF	FF
60	156.025	129	81	2C
61	156.075	131	83	2C
62	156.125	133	85	2C
63	156.175	135	87	6C
64	156.225	137	89	2C
65	156.275	139	8B	6C
66	156.325	141	8D	6C
67	156.375	143	8F	EC
68	156.425	145	91	EC
69	156.475	147	93	EC
70	156.525	149	95	EE
71	156.575	151	97	EC
72	156.625	153	99	EC
73	156.675	155	9B	EE
74	156.725	157	9D	EC
75	156.775	159	9F	EE
76	156.825	161	A1	EE
77	156.875	163	A3	EE
78	156.925	165	A5	6C
79	156.975	167	A7	6C
80	157.025	169	A9	6C
81	157.075	171	AB	6C
82	157.125	173	AD	6C
83	157.175	175	AF	6C
84	157.225	177	B1	2C
85	157.275	179	B3	2C
86	157.325	181	B5	2C
87	157.375	183	B7	2C
88	157.425	185	B9	6C
89		255	FF	FF
Private ch.				

10. COUNTRY VERSION FUNCTION CODE TABLES cont.:

Country Vers. Code C		Country Vers.: Germany, inland		
Channel No.	Normal Transmitter Frequency MHz	Frequency Code		Function Code in Hex. Number
		Ndec.	Hex	
00		255	FF	FF
01	156.050	130	82	6C
02	156.100	132	84	2C
03	156.150	134	86	2C
04	156.200	136	88	2C
05	156.250	138	8A	6C
06	156.300	140	8C	EC
07	156.350	142	8E	6C
08	156.400	144	90	EC
09	156.450	146	92	EC
10	156.500	148	94	EE
11	156.550	150	96	EE
12	156.600	152	98	EE
13	156.650	154	9A	EE
14	156.700	156	9C	EE
15	156.750	158	9E	EE
16	156.800	160	A0	EC
17	156.850	162	A2	EE
18	156.900	164	A4	6C
19	156.950	166	A6	6C
20	157.000	168	A8	2C
21	157.050	170	AA	6C
22	157.100	172	AC	6C
23	157.150	174	AE	6C
24	157.200	176	B0	2C
25	157.250	178	B2	2C
26	157.300	180	B4	2C
27	157.350	182	B6	2C
28	157.400	184	B8	2C
29		255	FF	FF
60	156.025	129	81	2C
61	156.075	131	83	2C
62	156.125	133	85	2C
63	156.175	135	87	6C
64	156.225	137	89	2C
65	156.275	139	8B	6C
66	156.325	141	8D	6C
67	156.375	143	8F	EC
68	156.425	145	91	EC
69	156.475	147	93	EC
70	156.525	149	95	EE
71	156.575	151	97	EC
72	156.625	153	99	EC
73	156.675	155	9B	EE
74	156.725	157	9D	EC
75	156.775	159	9F	EE
76	156.825	161	A1	EE
77	156.875	163	A3	EE
78	156.925	165	A5	6C
79	156.975	167	A7	6C
80	157.025	169	A9	6C
81	157.075	171	AB	6C
82	157.125	173	AD	6C
83	157.175	175	AF	6C
84	157.225	177	B1	2C
85	157.275	179	B3	2C
86	157.325	181	B5	2C
87	157.375	183	B7	2C
88	157.425	185	B9	6C
89		255	FF	FF
Private ch.				

10. COUNTRY VERSION FUNCTION CODE TABLES cont.:

Country Vers. Code D		Country Vers.: Holland, inland		
Channel No.	Normal Transmitter Frequency MHz	Frequency Code		Function Code in Hex. Number
		Ndec.	Hex	
00		255	FF	FF
01	156.050	130	82	6E
02	156.100	132	84	2E
03	156.150	134	86	2E
04	156.200	136	88	2E
05	156.250	138	8A	6E
06	156.300	140	8C	EE
07	156.350	142	8E	6C
08	156.400	144	90	EE
09	156.450	146	92	EE
10	156.500	148	94	EE
11	156.550	150	96	EE
12	156.600	152	98	EE
13	156.650	154	9A	EE
14	156.700	156	9C	EE
15	156.750	158	9E	EE
16	156.800	160	A0	EC
17	156.850	162	A2	EE
18	156.900	164	A4	6E
19	156.950	166	A6	6E
20	157.000	168	A8	2E
21	157.050	170	AA	6E
22	157.100	172	AC	6E
23	157.150	174	AE	6C
24	157.200	176	B0	2C
25	157.250	178	B2	2C
26	157.300	180	B4	2C
27	157.350	182	B6	2C
28	157.400	184	B8	2C
29		255	FF	FF
60	156.025	129	81	2E
61	156.075	131	83	2E
62	156.125	133	85	2E
63	156.175	135	87	6E
64	156.225	137	89	2E
65	156.275	139	8B	6E
66	156.325	141	8D	6E
67	156.375	143	8F	EE
68	156.425	145	91	EE
69	156.475	147	93	EE
70	156.525	149	95	EE
71	156.575	151	97	EE
72	156.625	153	99	EE
73	156.675	155	9B	EE
74	156.725	157	9D	EE
75	156.775	159	9F	EE
76	156.825	161	A1	EE
77	156.875	163	A3	EE
78	156.925	165	A5	6C
79	156.975	167	A7	6E
80	157.025	169	A9	6E
81	157.075	171	AB	6E
82	157.125	173	AD	6C
83	157.175	175	AF	6C
84	157.225	177	B1	2C
85	157.275	179	B3	2C
86	157.325	181	B5	2C
87	157.375	183	B7	2C
88	157.425	185	B9	6C
89		255	FF	FF
Private ch.				

10. COUNTRY VERSION FUNCTION CODE TABLES cont.:

Country Vers. Code F		Country Vers.: USA-version w. 1W on ch. 13/67		
Channel No.	Normal Frequency MHz	Transmitter Frequency Code		Function Code in Hex. Number
		Ndec.	Hex	
00		255	FF	FF
01	156.050	130	82	EC
02	156.100	132	84	2C
03	156.150	134	86	2C
04	156.200	136	88	2C
05	156.250	138	8A	EC
06	156.300	140	8C	EC
07	156.350	142	8E	EC
08	156.400	144	90	EC
09	156.450	146	92	EC
10	156.500	148	94	EC
11	156.550	150	96	EC
12	156.600	152	98	EC
13	156.650	154	9A	EC
14	156.700	156	9C	EC
15	156.750	158	9E	EC
16	156.800	160	A0	EC
17	156.850	162	A2	EC
18	156.900	164	A4	EC
19	156.950	166	A6	EC
20	157.000	168	A8	2C
21	157.050	170	AA	EC
22	157.100	172	AC	EC
23	157.150	174	AE	EC
24	157.200	176	B0	2C
25	157.250	178	B2	2C
26	157.300	180	B4	2C
27	157.350	182	B6	2C
28	157.400	184	B8	2C
29		255	FF	FF
60	156.025	129	81	2C
61	156.075	131	83	2C
62	156.125	133	85	2C
63	156.175	135	87	EC
64	156.225	137	89	2C
65	156.275	139	8B	EC
66	156.325	141	8D	EC
67	156.375	143	8F	EC
68	156.425	145	91	EC
69	156.475	147	93	EC
70	156.525	149	95	EC
71	156.575	151	97	EC
72	156.625	153	99	EC
73	156.675	155	9B	EC
74	156.725	157	9D	EC
75	156.775	159	9F	EE
76	156.825	161	A1	EE
77	156.875	163	A3	EC
78	156.925	165	A5	EC
79	156.975	167	A7	EC
80	157.025	169	A9	EC
81	157.075	171	AB	EC
82	157.125	173	AD	EC
83	157.175	175	AF	EC
84	157.225	177	B1	2C
85	157.275	179	B3	2C
86	157.325	181	B5	2C
87	157.375	183	B7	2C
88	157.425	185	B9	EC
89		255	FF	FF
Private ch.				
P1 - WX1	157.950	206	CE	3C
P2 - WX2	157.800	200	C8	3C
P3 - WX3	157.875	203	CB	3C
P4 - WX4	157.050	170	AA	3C

